

MI SYSTEMS



Boat, Motorhome and Commercial Vehicle Lighting & Accessories Catalogue



Photo by Rob Hayman

MI Systems is a family owned and operated company with over forty years of accumulated experience importing a wide range of low voltage lighting solutions. Whether you're in need of a durable light fitting to withstand hard working environments, backed by an impressive ten-year warranty or a cost effective but reliable light fitting, we can guide you through the best options to suit your project needs.

If you require lights for a one-off project, ongoing manufacturing or are interested in offering our wide range of lighting as a drop-shipping option, reach out and we are always happy to accommodate where we can.

Our three key ranges consist of Labcraft, Bestlight and our in-house brand MI Lighting, all of which provide reliable lighting solutions for motorhomes, boats, off the grid housing, tiny homes and retail displays.

Contents

Interior Lighting	
Cabin Lights	5
Down Lights	26
Reading Lights	33
Step Lights	40
Exterior Lighting	
Awning Lights	44
Outdoor Lights	55
Work Lights	65
Replacement Parts & Accessories	67

Key – look out for the below stickers on a range of lights throughout the catalogue.



Lights currently or previously used in motorhome manufacture throughout Australasia



This symbol is applied to our most cost effective line items for each category



Our most durable products that come with a 10 year warranty

All measurements in millimetres.

QR CODES

Where we have additional information such as product comparisons, demonstrations or other additional information you may see a QR code. Scan this with your phone camera to see more.

SCAN HERE

To watch a demonstrational video on the Banksman BM3



INTERIOR LIGHTING

Cabin Lights

Luna	5
Coronet	6
Iris	7
Crux Series	8
Sitara & Syliva	13
Lucina	14
Flux	15
Estella	16
Portia	17
Carina	18
Kira	19
DX Linear	20
Juno	21
Trix	22
Cordelia	23
Sashi	24
Gamma	25

Down Lights

Ascent	26
Dawn	27
Halley	28
Norma	29
Indu & Pandora	30
DownLite	31
Elara	32

Reading Lights

Map Light	33
Swift	34
FlexSpot	35
EcoSpot	36
USB SpotLite	37
Tara	38
Elen & Hina	39
Vela	40

Step Lights

Vesta	40
Steplite	41

Luna



Product Description

The round Luna dome light is ideal for use in interior spaces where a large diameter light fitting is required. This minimalist design gives a timeless look, making it a great addition to any motorhome, caravan or boat cabin. It is surface mounted with an ABS base and frosted PC lens to softly diffuse its cool white light. The Luna is easily operated with a two-position rocker switch.

Summary

- White or Satin finish
- Rocker switch
- 72 Cool White LEDs
- Surface mounted
- Ø250 x H65 mm

Product	Voltage/V	Current/A	Power/W	LED Colour	Finish
J820	12	1.0	12	Cool White	White
J820S	12	1.0	12	Cool White	Satin

Coronet

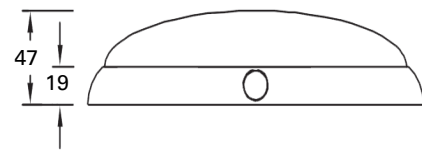
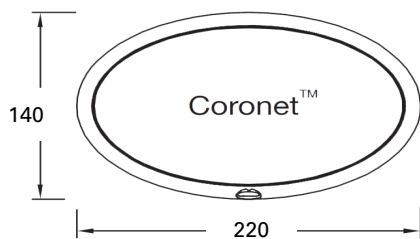

Product Description

The Coronet is an oval-shaped surface mounted light fitting, suitable for either ceiling or wall mounting. With a stylish satin finish and convenient rocker switch, the Coronet is classic fitting and a great solution for upgrading existing fluorescent Coronet lights fitted in boats and motorhomes throughout Australasia. It features a High Impact Polystyrene diffuser for an even, bright light output.

Summary

- Satin Finish
- Rocker Switch
- 28 Daylight LEDs
- Surface Mounted
- Daylight LED Colour
- 290 Lumens
- L220 x W140 x H47mm

Product	Voltage/V	Current/A	Power/W	LED Colour
F2091	12	0.3	4.0	Daylight

Iris



Product Description

The Iris is an affordable and durable water resistant light constructed of a PC base and lens. Available in a wide range of options to suit your boat or motorhome. The three-position rocker switch gives the option to dim the light in white or red and the unswitched variety features 3 wires to allow for an external 3 position switch to provide a dimming option if desired. A sealed switch cover provides the light with a IP66 rating whether you opt for a switched or unswitched variant.

Summary

- White or satin finish
- Rocker switch or unswitched
- 18 Daylight + 12 Red or white dim LEDs
- Surface mounted
- 126 Lumens
- IP66
- Ø150 x H25 mm

Product	Voltage/V	Current/A	Power/W	LED colour	Finish	Switch
J6881	12	0.23	3.0	Daylight + White Dim	White	-
J6882	12	0.23	3.0	Daylight + White Dim	Satin	-
J6891	12	0.23	3.0	Daylight + White Dim	White	✓
J6892	12	0.23	3.0	Daylight + White Dim	Satin	✓
J6893	12	0.23	3.0	Daylight + Red Dim	White	✓
J6894	12	0.23	3.0	Daylight + Red Dim	Satin	✓
J6895	24	0.12	3.0	Daylight + White Dim	White	✓
J6896	24	0.12	3.0	Daylight + White Dim	Satin	✓
J6897	24	0.12	3.0	Daylight + Red Dim	White	✓
J6898	24	0.12	3.0	Daylight + Red Dim	Satin	✓

Crux Series

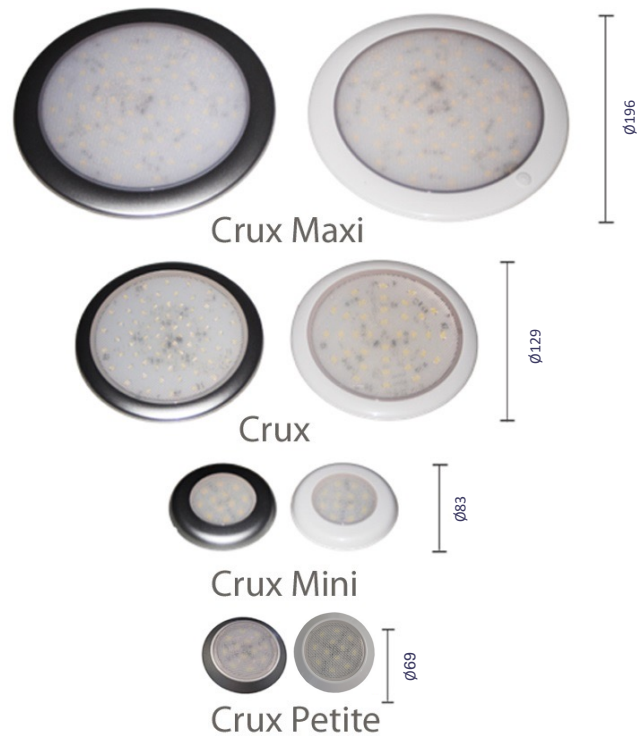

The Crux series is a coordinated range of sleek light fittings for lighting spaces in your motorhome, caravan or boat cabin. All four variants have a slim profile, allowing you to maximise valuable headspace without the need to use recessed light fittings.

The Crux series is available with multiple variants, providing you with a choice of bezel colour, voltage, switch, LED colour and dimming options. The unswitched Crux lights have a waterproof rating of IP66 and can be used in some outdoor settings. The Crux lights are constructed with a frosted PC lens. The Crux and Crux Maxi have an aluminium base and the Crux Mini and Crux Petite have plastic bases.

Product	Power/W	Light Output/lm	No of LEDs	Diameter/mm
Crux Maxi	13	1152	72	196
Crux	6.5	576	36	129
Crux Mini	2.0	175	12	83
Crux Petite	2.0	175	12	69

Crux Maxi



Product Description

The Crux Maxi is the largest light in the Crux series making it great for general cabin or tiny home lighting. The Crux Maxi comes in both white and satin finishes as well as the option to dim the light fitting to a white or red dim for night navigation, power savings or a softer light output. The unswitched variant has an IP66 rating making it suitable for damp environments as well as indoor use while the switched variant contains a subtle push switch.

Summary

- White or satin finish
- Push switch or unswitched
- 72 LEDs + 12 LED dim options
- Surface mounted
- 1152 lumens
- IP66 (unswitched only)
- Ø196 x H9.5 mm

Product	Voltage/V	Current/A	Power/W	LED colour	Finish	Switch
J88182	24	0.5	13	Cool White	Satin / Round	-
J88183	12	1.0	13	Warm White	Satin / Round	-
J88184	12	1.0	13	Cool White	White / Round	-
J88185	12	1.0	13	Warm White	Satin / Sharp	-
J88186	12	1.0	13	Cool White	Satin / Sharp	-
J88187	12	1.0	13	Cool White + Red Dim	Satin / Round	✓
J88188	12	1.0	13	Warm White + Red Dim	White / Round	✓
J881891	12	1.0	13	Cool White + White Dim	Satin / Round	✓
J881892	24	0.5	13	Cool White + White Dim	Satin / Round	✓
J881893	24	0.5	13	Cool White + Red Dim	Satin / Round	✓
J881894	12	1.0	13	Warm White + White Dim	Satin / Round	✓
J881895	24	0.5	13	Cool White + Red Dim	Satin / Round	-
J881896	12	1.0	13	Cool White + White Dim	White / Round	✓
J881898	24	0.5	13	Warm White + White Dim	Satin / Round	-

Crux



Product Description

The Crux is a round ceiling light with a clean and timeless look. Its choice of a white or satin bezel ensures that fits with the look of most motorhome or boat interiors. A number of variants feature a white or red dim which allows the user to preserve night vision or opt for a more subtle mood lighting when the full brightness is not required. The switched variant is controlled by a convenient touch sensor allowing you to tap any two spots on the outer bezel to switch the light between on, its dim option or off.

Summary

- White or satin finish
- Touch switch or unswitched
- 36 LEDs + 6 LED dim Options
- Surface mounted
- 576 lumens
- IP66
- Slim profile
- Ø129 x H9 mm

Product	Voltage/V	Current/A	Power/W	LED colour	Finish	Switch
J88121	12	0.5	6.5	Cool White+ White dim	White / Round	-
J88122	24	0.3	6.5	Cool White + White dim	Satin / Sharp	-
J88123	12	0.5	6.5	Warm White	Satin / Round	-
J88124	12	0.5	6.5	Warm White	White / Round	-
J88125	12	0.5	6.5	Warm White	Satin / Sharp	-
J88127	12	0.5	6.5	Cool White + Red Dim	Satin / Round	✓
J88128	12	0.5	6.5	Warm White + Red Dim	White / Round	✓
J881291	12	0.5	6.5	Cool White + White Dim	Satin / Round	✓
J881292	24	0.3	6.5	Cool White + Red Dim	Satin / Round	✓
J881293	24	0.3	6.5	Cool White + White Dim	White / Round	✓
J881294	12	0.5	6.5	Warm White + White Dim	Satin / Round	✓
J881295	12	0.5	6.5	Cool White + Red Dim	Satin / Round	-

Crux Mini



Product Description

The Crux Mini is the most popular of the Crux series. Its convenient size and variety of options makes it a great choice where smaller amounts of additional lighting is desired such as cabin areas or in a row overhead for general lighting. The unswitched variant of the Crux Mini has an IP rating of IP66 making it suitable for use in damp areas as well as indoors. The switched variant contains a simple push switch to toggle through lighting options.

Summary

- White or satin finish
- Push switch or unswitched
- 12 LEDs + 6 LED dim options
- Surface mounted
- 175 lumens
- IP66 (unswitched only)
- Ø83 x H12 mm

Product	Voltage/V	Current/A	Power/W	LED colour	Finish	Switch
J1001	12	0.15	1.75	Warm White	White	-
J1002	12	0.15	1.75	Warm White	Satin	-
J1003	12	0.15	1.75	Warm White	White	✓
J1004	12	0.15	1.75	Warm White	Satin	✓
J1005	12	0.15	1.75	Cool White	White	-
J1006	12	0.15	1.75	Cool White	Satin	-
J1007	12	0.15	1.75	Cool White + Red Dim	Satin	✓
J1009	24	0.08	1.75	Red	Satin	✓
J10091	12	0.15	1.75	Cool White	Satin	✓
J10092	12	0.15	1.75	Cool White + Blue Dim	Satin	-
J10093	12	0.15	1.75	Cool White + Blue Dim	Satin	✓
J10094	12	0.15	1.75	Red	Satin	✓
J10099	12	0.15	1.75	Cool White	White	✓

Crux Petite



Product Description

The Crux Petite is the smallest light in the Crux series. It is available in a white or satin finish and provides the same light output as the crux mini but with a slimmer profile and smaller diameter. Thanks to the discrete touch switch, the Crux Petite is waterproof with a rating of IP66. This makes the Crux Petite an ideal option for when you would like a compact light fitting without compromising on light output.

Summary

- Satin or white finish
- Touch switch or unswitched
- 12 Cool White + 6 LED dim
- Surface mounted
- 175 Lumens
- IP66
- Ø69 x H9.6 mm

Product	Voltage/V	Current/A	Power/W	LED Colour	Finish	Switch
J0561	12	0.15	1.75	Cool White + Blue Dim	Satin	-
J0562	12	0.15	1.75	Cool White + Red Dim	White	-
J0563	12	0.15	1.75	Cool White + Blue Dim	White	✓
J0564	12	0.15	1.75	Cool White + Red Dim	Satin	✓

Sitara



Product Description

The Sitara is a brass dome light with a frosted lens and toggle switch. It is a surface mounted light fitting, well suited to older boats or motorhomes that desire a classic styled light paired with modern LEDs meaning that replacing your current light fittings doesn't compromise on character, feel or function.

Summary

- Brass finish
- Toggle switch
- 24 Cool white LEDs
- Surface mounted
- Ø140 x H40 mm

Product	Voltage/V	Current/A	Power/W	LED Colour
J104B	12	0.2	2.0	Cool White

Sylvia



Product Description

The Sylvia dome light is ideal for use in motorhomes or boats that would like to retain an old character feel while still utilising modern LED technology. The Sylvia is available in both surface mounted or recess mounted options to suit your requirements. The switched variant contains a toggle switch for easy operation.

Summary

- Chrome finish
- Toggle switch or unswitched
- 30 Cool white LEDs
- Surface or recess mount options
- IP66
- J6901-Ø120 x H21 mm
- J6903-Ø137 x H21 mm

Product	Voltage/V	Current/A	Power/W	Switch	Mount
J6901	12	0.2	3.0	-	Recess
J6903	12	0.2	3.0	✓	Surface



Lucina



Product Description

The Lucina range is an extensive variety of surface mounted cabin lights, ideal for replacing fluorescent light fittings or for when a high level of light output is required. The range of sizes allows for creating a unified look throughout your boat or motorhome. It features a discrete memory push switch that remembers the last setting before power was removed, making it effective where an external switch is also desired.

Summary

- White or satin finish
- Memory push switch
- 48-240 LEDs
- Surface mounted
- Up to 1440 lumens
- Lengths 186-606mm
- W93 x H16 mm

Product	Length/mm	Voltage/V	Current/A	Power/W	No of LEDs	Light Output/lm	LED colour	Finish
J2501-201	186	12	0.3	3.5	48	288	Cool White	White
J2501-202	186	12	0.3	3.5	48	288	Cool White	Satin
J2501-203	186	12	0.3	3.5	48	288	Warm White	Satin
J2501-204	186	24	0.1	3.5	48	288	Cool White	White
J2501-301	292	12	0.6	7.5	96	576	Cool White	White
J2501-302	292	12	0.6	7.5	96	576	Cool White	Satin
J2501-303	292	12	0.6	7.5	96	576	Warm White	White
J2501-304	292	12	0.6	7.5	96	576	Warm White	Satin
J2501-305	292	24	0.3	7.5	96	576	Cool White	White
J2501-401	397	12	0.8	10	144	864	Cool White	White
J2501-402	397	12	0.8	10	144	864	Warm White	White
J2501-403	397	24	0.4	10	144	864	Cool White	White
J2501-404	397	24	0.4	10	144	864	Cool White + Red Dim	White
J2501-405	397	12	0.8	10	144	864	Cool White	Satin
J2501-601	606	12	1.5	18	240	1440	Cool White	White
J2501-602	606	12	1.5	18	240	1440	Warm White	White
J2501-603	606	24	0.8	18	240	1440	Cool White	White

Flux

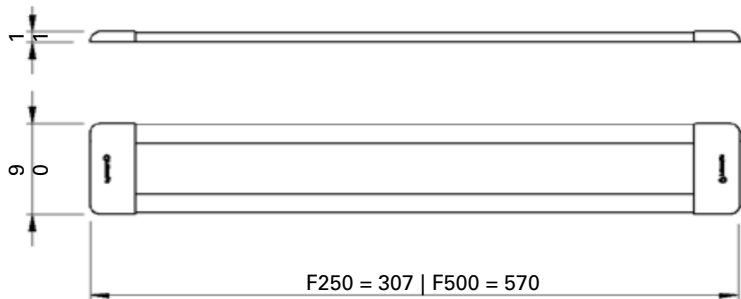

Product Description

The Flux light is a slim, low profile and clean white finished light fitting available in a choice of two lengths. The Flux has a choice of lighting levels and is available with blue LEDs for trauma lighting in emergency vehicles. The acrylic LGP offers a unique anti-glare light guide, dispersing light evenly and providing a clean and sharp field of light.

Summary

- White finish
- Unswitched
- 24 - 96 Cool White LEDs
- Surface mounted
- Up to 2350 lumens
- Length 307 or 570mm
- W90 x H11 mm

Product	Length/mm	Voltage/V	Current/A	Power/W	No of LEDs	Light Output/lm	LED Colour
F250-24	307	12	0.63	7.5	24	587	Cool White
F250-48	307	12	1.22	15	48	1175	Cool White
F500-48	570	12	1.22	15	48	1175	Cool White
F500-96	570	12	2.5	30	96	2350	Cool White
F500-96T	570	12	2.6	31	96	2350	Cool White + Blue Dim

All variants except F500-96T are available in 24V on request

Estella



Product Description

The Estella surface mounted LED strip light is an ideal option for either discrete lighting or updating old fluorescent lights to LED when a suitable replacement fitting cannot be sourced. The Estella is a rigid LED strip available in three convenient lengths to suit a wide range of projects, the strips can also be trimmed down at indicated points between the LEDs to offer a more customised fit if required, while screw mounts or double-sided tape can be used for a clean and easy installation.

Summary

- Unswitched
- Daylight colour LEDs
- Surface mounted
- Length 290-1000mm
- W10 x H1.5 mm

Product	Length/mm	Voltage/V	Current/A	Power/W	No of LEDs	LED Colour
F2585	290	12	0.2	2.5	18	Daylight
F2586	490	12	0.3	4	30	Daylight
F2588	1000	12	0.7	8	60	Daylight

Portia



Product Description

The Portia is a sturdy, rotatable strip light available in two lengths, with an aluminium body it can swivel up to 270 degrees, shifting the direction of light to illuminate where light is most required. Ideal for overhead lighting in cabins and living areas of modern leisure vehicles. Its plastic end covers have a satin finish to fit in with similar interior fittings and contains a two-position rocker switch for easy operation.

Summary

- Satin finish
- Rocker switch
- 9-24 Cool white LEDs
- Surface mounted
- Up to 384 lumens
- Ability to swivel
- Length 220 or 470mm
- W35 x H31 mm

Product	Length/mm	Voltage/V	Current/A	Power/W	No of LEDs	Light Output/lm	LED Colour
J280	470	12	0.13	1.5	24	384	Cool White
J2801	220	12	0.06	0.8	9	144	Cool White

Carina



Product Description

The Carina is a satin strip light, constructed of an ABS base, and controlled by a two-position rocker switch. The surface mounted Carina is a great choice for a simple affordable strip light in any boat or motorhome as well as an excellent LED replacement for its fluorescent predecessor found in many boats and motorhomes throughout Australasia.

Summary

- Satin finish
- Rocker switch
- 18 Cool white LEDs
- Surface mounted
- L390 x W50 x H36 mm

Product	Voltage/V	Current/A	Power/W	LED Colour
J2708	12	0.25	3.0	Cool White
J2708 24V	24	0.13	3.0	Cool White

Kira

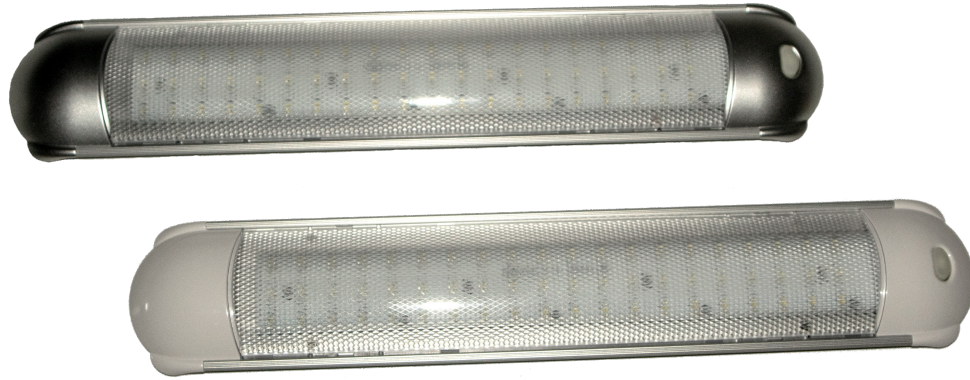

Product Description

The Kira cabin light is a low-profile, surface mounted ceiling light. It is constructed of an aluminium base, ABS end covers and a frosted PC lens for a more evenly distributed light output. The Kira is available in satin and white finishes with a choice of cool white or warm white LEDs. Due to its dimensions, It is ideal for replacing most single tube fluorescent light fittings and features a push switch that glows in the dark for easy operation.

Summary

- White or satin finish
- Glow in the dark push switch
- 60 Cool white or warm white LEDs
- Surface mounted
- 335 lumens
- L383 x W70 x H18 mm

Product	Voltage/V	Current/A	Power/W	LED Colour	Finish
JM7011	10-30	0.42	5.0	Cool White	Satin
JM7012	10-30	0.42	5.0	Warm White	White
JM7013	10-30	0.42	5.0	Cool White	White

Amps measured at 12V

DX Linear

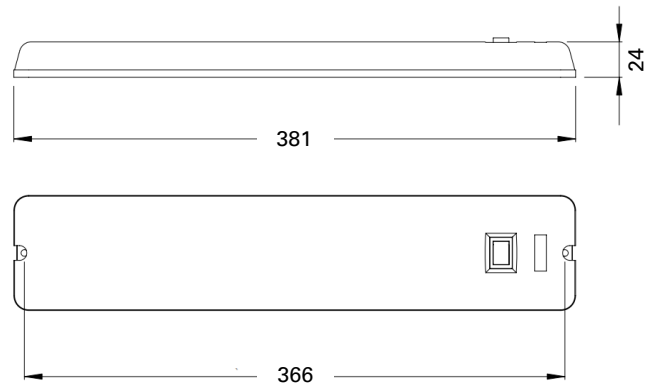
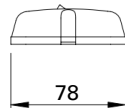

Product Description

The DX Linear surface mounted light is ideal for use in boats and motorhomes to replace a range of fluorescent light fittings. The DX Linear uses long life CREE LEDs offering optimum performance and powerful light output. It is quick to install and fits the same profile as existing fluorescent Labcraft DX fixings, allowing an easy upgrade to more efficient LED technology. The integrated rocker switch makes the DX Linear simple to operate and easy to install.

Summary

- Clear PC lens
- Rocker switch
- Up to 36 Cool White LEDs
- Surface mounted
- Up to 960 lumens
- IP50
- L381 x W78 x H24 mm

Product	Voltage/V	Current/A	Power/W	No of LEDs	Light Output/lm	LED Colour
DX LED12	12	0.25	3.0	12	320	Cool White
DX LED24	12	0.44	6.0	24	640	Cool White
DX LED36	12	0.75	9.0	36	960	Cool White

All variants available in 24V on request

Juno



Product Description

The Juno is a great choice for a slim but powerful ceiling light to provide for general lighting needs. This surface-mounted light is available in white or satin finishes depending on your interior décor and can be purchased with cool or warm white LEDs. The Juno is available in an unswitched variant or with a minimal impact switch to provide convenient switching if desired.

Summary

- White or satin finish
- Push switch or unswitched
- 72 LEDs
- Surface mounted
- 504 lumens
- L368 x W45 x H10 mm

Product	Voltage/V	Current/A	Power/W	LED colour	Finish	Switch
J25101	12	0.4	5.7	Cool White	Satin	✓
J25102	12	0.4	5.7	Cool White	White	✓
J25103	24	0.2	5.7	Cool White	Satin	✓
J25104	24	0.2	5.7	Cool White	White	✓
J25105	12	0.4	5.7	Warm White	Satin	✓
J25106	12	0.4	5.7	Warm White	White	✓
J25107	12	0.4	5.7	Cool White	White	-
J25109	12	0.4	5.7	Cool White	Satin	-
J251091	24	0.2	5.7	Cool White	White	-

Trix

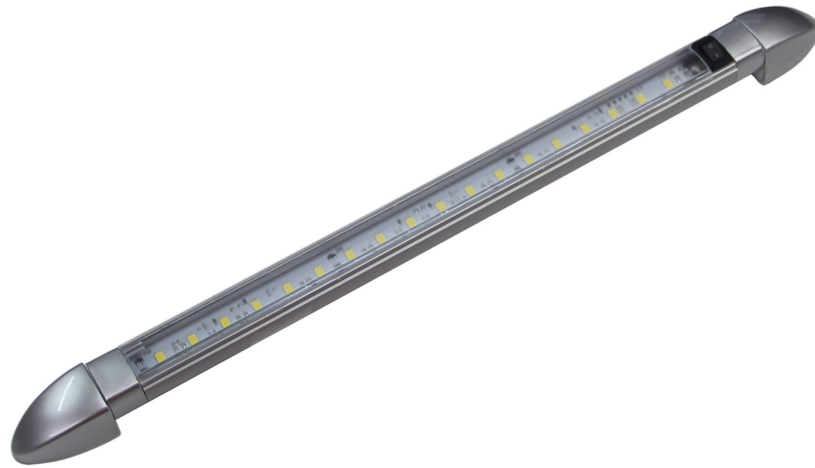

Product Description

The Trix is a versatile and powerful LED strip light with the ability to rotate the direction of light thanks to its 270° swivel. It's a fantastic option for surface mounting under cabinets or as benchtop lighting in motorhomes or boats with its user-friendly design. This best-seller features an aluminium base, PC lens and satin endcaps and comes with a discrete rocker switch. If desired, some options allow for either red or blue dimmed LEDs, ideal for reduced illumination needed during night sailing or to create mood lighting.

Summary

- Satin finish
- Rocker switch
- 18 LEDs with red or blue dim options
- Surface mounted
- 288 lumens
- Ability to swivel 270°
- L350 x W21 x H15 mm

Product	Voltage/V	Current/A	Power/W	LED colour
J2901	24	0.1	2.5	Cool White
J2902	12	0.2	2.5	Cool White
J2903	12	0.2	2.5	Warm White
J2904	12	0.2	2.5	Cool White + Red Dim
J2905	12	0.2	2.5	Cool White + Blue Dim

Cordelia

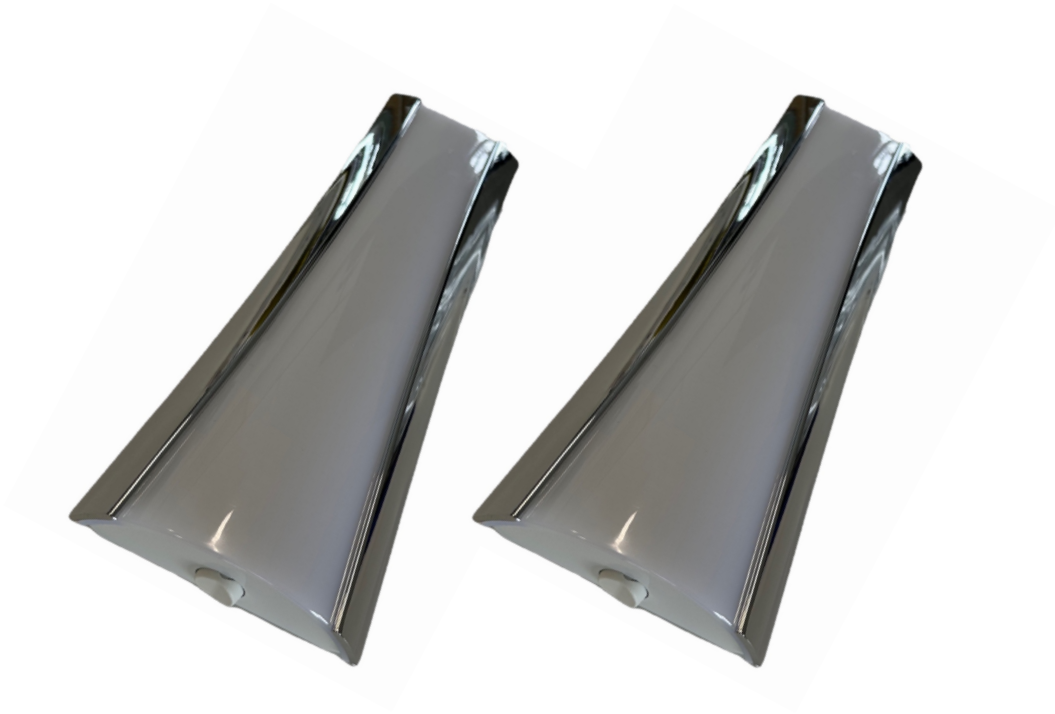

Product Description

The Cordelia light comes in a co-ordinated pair, designed for mounting in the corners of motorhomes and tiny homes providing convenient outward pointing lighting into your cabin area. The Cordelias warm white light is softly diffused by its white ABS diffuser and the chrome finish is sleek enough to fit in with a range of boat and motorhome interiors. Choosing the Cordelia corner lights allows you to maximise on headroom space while providing convenient and accessible switching.

Summary

- Chrome finish
- Rocker switch
- 18 Warm White LEDs
- Surface mounted
- L230 x W85mm (at widest point)

Product	Voltage/V	Current/A	Power/W	LED Colour
SCS12	12	0.1	1.2	Warm White

Sashi



Product Description

The Sashi ceiling light is a stylish, square shaped, super bright light with a satin finish. Available in cool white or warm white, this surface mounted light is perfect for lighting general cabin spaces and is easily operated with a push switch in the centre of the light. Both options dim to red LEDs to preserve night vision.

Summary

- Satin finish
- Push switch
- 60 LEDs with Red dim
- Surface mounted
- L177 x W177 x H20 mm

Product	Voltage/V	Current/A	Power/W	LED Colour
J9001 CW	10-30	0.4	5.0	Cool White + Red Dim
J9001 WW	10-30	0.4	5.0	Warm White + Red Dim

Amps measured at 12V

Gamma



Product Description

The Gamma is a slim, white ceiling light, constructed of a PC base and lens. The unswitched Gamma variant is suitable for boats or other damp environments where a hard wearing, bright light is required as it has a high dust and waterproof rating. The Gamma is also available as a non-waterproof fitting with an easy-to-use rocker switch.

Summary

- White finish
- Rocker switch or unswitched
- 36 Cool white or warm white LEDs
- Surface mounted
- 575 Lumens
- IP66 (unswitched only)
- L185 x W110 x H24 mm

Product	Voltage/V	Current/A	Power/W	LED colour	Switch
J5581	12	0.50	6.0	Cool White	✓
J5582	24	0.25	6.0	Cool White	✓
J5583	12	0.50	6.0	Cool White	-
J5584	24	0.25	6.0	Cool White	-
J5585	24	0.25	6.0	Warm White	✓
J5586	24	0.25	6.0	Warm White	✓

Ascent

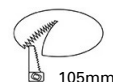

Product Description

The Ascent is a large diameter recessed ceiling light, a great option for when upgrading existing large recessed light fittings or when wishing to maximise headroom in your boat or motorhome. The ascent comes unswitched and with three wires allowing it to be wired into a three-way switch if desired to give the option of dimming the light for ambient lighting and additional power savings.

Summary

- Satin finish
- Unswitched
- Cool white LEDs + Dim
- Recess mounted
- IP66
- Ø132mm

Product	Voltage/V	Current/A	Power/W	LED Colour
J7071	12	0.23	3.0	Cool White

Dawn



Product Description

The Dawn is a modern design, surface mounted halogen light with a brushed nickel finish. The Dawn contains a mini rocker switch or can be modified to an unswitched recess downlight by pushing the light fitting out of the switched surround. Fitting is similar to one found on a range of cruising boats, is cost effective and is easily convertible to LED by inserting a G4 LED bulb, which can be purchased separately.

Summary

- Brushed nickel finish
- Mini rocker switch
- 10W halogen bulb
- Surface or recess mounted
- Ø96.5 x H32 mm

Product	Voltage/V	Current/A	Power/W	LED Colour
HDL-203	12	0.8	10	Cool White
B-G4 6SMD CW SP	G4 LED bulb in cool white, compatible with Dawn light fitting			
B-G4 6SMD WW SP	G4 LED bulb in warm white, compatible with Dawn light fitting			

Halley

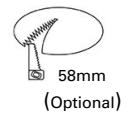

Product Description

The Halley light is a convenient fitting to upgrade similar existing halogen light fittings found in a range of motorhomes to LED. The Halley can be easily changed from a surface mount to low-profile recess fitting by pushing the front plate out of the light extrusion. Doing so does not impact the functionality of the two-position rocker switch.

Summary

- White or satin finish
- Rocker switch
- 9 Cool white LEDs
- Surface or recess mounted
- 108 lumens
- Ø80 x H30 mm

Product	Voltage/V	Current/A	Power/W	LED Colour	Finish
J0091	12	0.06	0.8	Cool White	Satin
J0092	12	0.06	0.8	Cool White	White

Norma



Product Description

The Norma is a classic style down light available in a white or satin finish to suit your boat or motorhome interior.

Perfect for lighting smaller areas such as lofts or cabins. The Norma is a versatile choice as it can be both surface or recess mounted for a low-profile fitting. It contains a push switch for easy control of the 9 super bright LEDs.

Summary

- White or satin finish
- Push switch
- 9 Cool white LEDs
- Surface or recess mounted
- Ø80 x H20 mm

Product	Voltage/V	Current/A	Power/W	LED Colour	Finish	Mount
J0992	12	0.15	1.8	Cool White	Satin	Recess or surface
J0993	12	0.15	1.8	Cool White	White	Recessed only
J0994	12	0.15	1.8	Cool White	White	Recess or surface

Indu



Product Description

The Indu is a reliable, cost effective, recessed down light. It contains daylight-coloured LEDs surrounded by a simple white bezel giving the light a clean and modern appearance in any boat or motorhome.

Summary

- White finish
- Unswitched
- 24 Daylight LEDs
- Recess mount
- Ø70mm

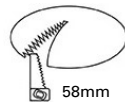

Product	Voltage/V	Current/A	Power/W	LED Colour
J019	12	0.13	1.5	Daylight

Pandora

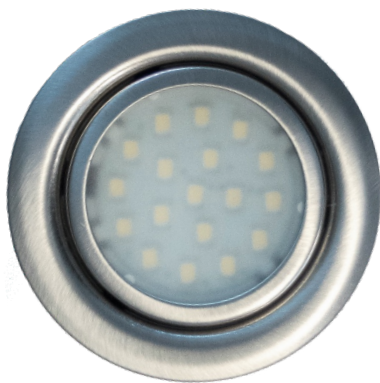

Product Description

The Pandora is a great option for an economical and stylish recessed light. The down light has a modern brushed nickel finish with a glass fog lens. The wiring includes a black mini connector for easy installation in many motorhome rangehoods to replace or update your rangehood light with ease. Or, if desired the mini connector can be easily cut away for standard installations.

Summary

- Brushed nickel finish
- Unswitched
- 18 Daylight LEDs
- Recess mount
- Black mini connector
- Ø69mm



Product	Voltage/V	Current/A	Power/W	LED Colour
LS-012A	12	0.15	1.8	Daylight

DownLite

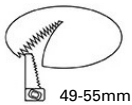
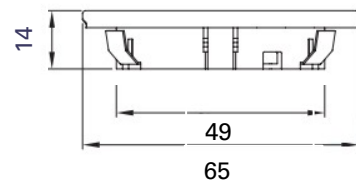
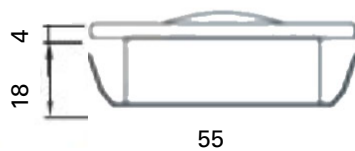
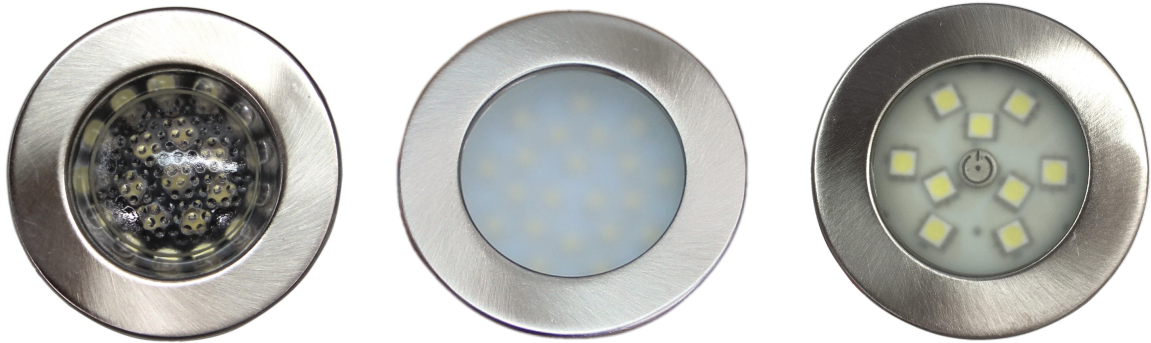

Product Description

The DownLite series contains a range of small recessed lights, an ideal solution for lighting most cabin spaces. The downlights all feature a modern brushed nickel finish with a variety of diffuser and LED colours to suit most preferences. The touch switch downlights can be easily switched on and off by tapping the power button in the centre and dimmed up and down simply by holding your finger on the blue power icon.

Summary

- Brushed nickel finish
- Touch switch or unswitched
- 9 or 21 LEDs
- Recessed mount
- Up to 65 lumens
- Ø65mm

Product	Voltage/V	Current/A	Power/W	No of LEDs	LED Colour	Switch
F2485	12	0.2	2.0	21	Cool White	-
F2486	12	0.2	2.0	21	Warm White	-
F2578	12	0.2	2.0	21	Daylight	-
F2589	12	0.2	2.0	9	Warm White	✓
F2596	12	0.2	2.0	9	Cool White	✓

Shown in image (left to right): F2585, F2578, F2596

Elara Step Lite

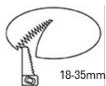
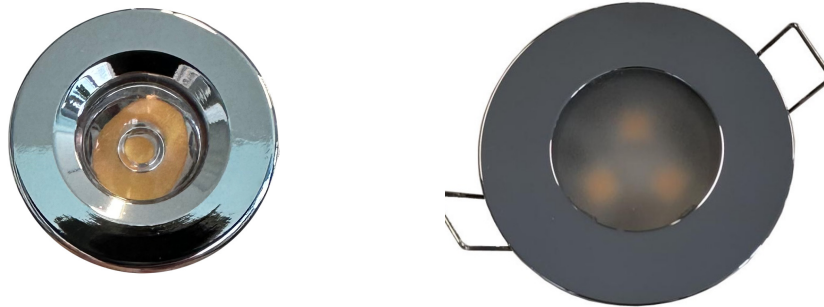

Product Description

The Elara Step light range consists of two small recess mount lights, ideal for providing compact and discrete illumination in boat and motorhome pathways, stairwells or cabins. It's recess mount and chrome finish offers a subtle, modern look to any interior while its low power consumption makes the fittings cost effective and a great choice for ambient lighting.

Summary

- Chrome Finish
- Unswitched
- Warm white LEDs
- Recess Mount
- 30-50 Lumens

Product	Voltage/V	Current/A	Power/W	LED Colour	Finish
F2908	12	0.042	0.5	Warm White	Chrome
F2518	12	0.05	0.6	Warm White	Chrome

Shown in image (left to right): F2908, F2518

Map Light

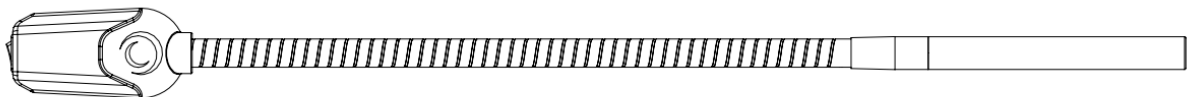
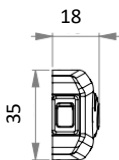
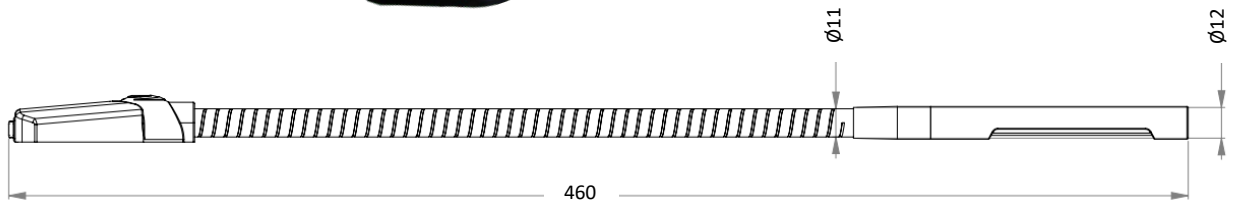

Product Description

The Map Light is an innovative lighting solution for bed head lighting in mobile homes and as a chart light in boats with its adjustable neck and slimline design. The efficient Map Light is easily operated by an integrated rocker switch on the base of the light and produces white or red light by simply rotating the lens on the top of the light. This is particularly useful to preserve night vision when driving or boating.

Summary

- Black finish
- Rocker switch
- 6 Cool White LEDs with swivel red lens
- Surface mounted
- 72 lumens
- L460 x W35 x H18 mm

Product	Voltage/V	Current/A	Power/W	LED Colour
ML2271	12	0.07	0.85	Cool White + Red

Swift



Product Description

The Swift reading light is a tidy black satin chart light with a long flexible neck and a high light output. The Swift is available with cool white LEDs and includes red dimmed option ideal for night navigation if desired. Operated by a mini rocker switch on the head of the light; the flexible functionality makes it easy to direct the bright beam for bed head lighting in motorhomes or map reading in boat cabins.

Summary

- Black and Satin finish
- Rocker switch
- 12 Cool white + red dim LED option
- Surface mounted
- 192 lumens
- Length 410mm

Product	Voltage/V	Current/A	Power/W	LED Colour
J50661	12	0.2	2.4	Cool White
J50663	12	0.2	2.4	Cool White + Red Dim

FlexSpot

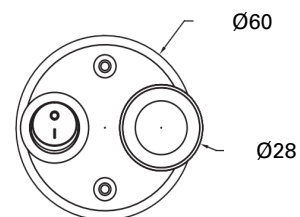
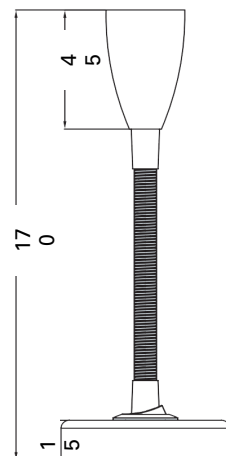

Product Description

The FlexSpot is a versatile light with a flexible neck and a clean, modern aesthetic. The FlexSpot is available with a brushed nickel finish and has a cool or warm white light output. It is surface mounted with an integrated switch, plus the flexible neck swivels and bends, giving you the freedom to direct the light to where it is needed most in cabins, kitchenette areas or as a reading light.

Summary

- Brushed nickel finish
- Rocker switch
- 1 x 1.5W Cool white or warm white LED
- Surface mount
- 50 lumens
- Ø60 x L170 mm

Product	Voltage/V	Current/A	Power/W	LED Colour
F2563	12	0.13	1.5	Cool White
F2564	12	0.13	1.5	Warm White

EcoSpot

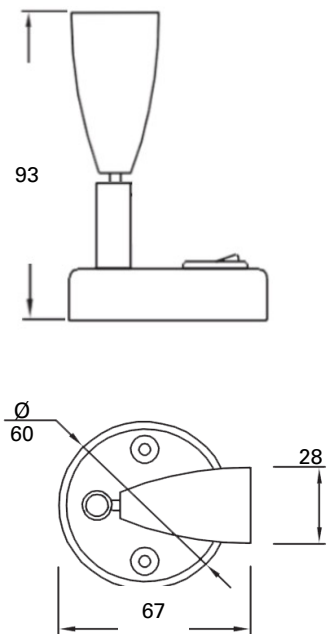

Product Description

The EcoSpot is an affordable, compact reading light found in motorhomes throughout Australasia. The direction of light can be easily adjusted thanks to its swivel head ensuring light is directed to where you need it most. The aesthetic brushed nickel finish is a stylish lighting solution that suits a range of boat and motorhome interiors. If using in a 24V system, the Ecospot has enough space in the base of the light to discretely fit a C1 voltage reducer to make the light compatible with 24V.

Summary

- Brushed nickel finish
- Rocker switch
- 1 x 1.5W Cool white or warm white LED
- Surface mount
- 55 lumens
- Ability to swivel
- Ø60 x 93mm

Product	Voltage/V	Current/A	Power/W	LED Colour
F2535	12	0.13	1.5	Warm White
F2536	12	0.13	1.5	Cool White

USB SpotLite

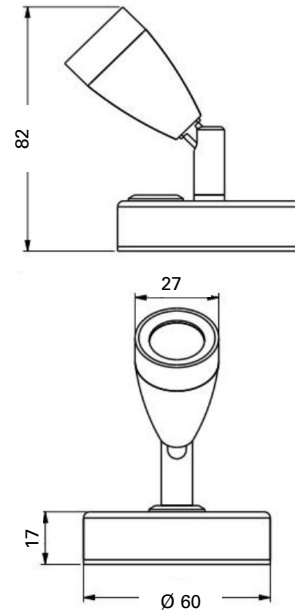

Product Description

The USB SpotLite is a stylish and energy efficient lighting solution for modern leisure vehicles and boats. It contains a sleek touch switch with blue back light to provide a dimmable warm white light perfect for reading or ambient lighting. Hold your finger down on the touch switch to alter the dimming of the light to provide optimum light control. The USB Spotlite contains a 2.1A USB charging port so you can conveniently charge electronics. The USB spotlight is available in chrome or a brushed nickel finish depending on your preference.

Summary

- Chrome or Brushed Nickel finish
- Touch switch
- 1 x 1.0W Warm White LED
- Surface mount
- 50 lumens
- 2.1A USB charge port
- Ability to swivel
- Ø60 x H82 mm

Product	Voltage/V	Current/A	Power/W	LED Colour	Finish
F2900	12	0.1	1.0	Warm White	Chrome
F2900B	12	0.1	1.0	Warm White	Brushed Nickel

Tara



Product Description

The Tara is a compact reading light, operated by a mini rocker switch. There are three variants available, containing different lighting configurations, depending on your desired light output and budget. The Tara is constructed from an ABS base with a choice of a white or satin finish to suit a wide range of boat and motorhome interiors.

Summary

- White or satin finish
- Rocker switch
- 3-24 Cool white or warm white LEDs
- Surface mounted
- Ability to swivel
- L80 x W42 x H86 mm

Product	Voltage/V	Current/A	Power/W	LED Colour	Finish
J9391	12	0.15	2.0	Cool White	Satin
J9392	12	0.25	3.0	Cool White	Satin
J9393	12	0.25	3.0	Cool White	White
J9394	12	0.08	1.0	Cool White	Satin
J9395	12	0.08	1.0	Warm White	Satin
J9396	12	0.08	1.0	Cool White	White

Shown in image (left to right): J9393, J9391, J9396

Elen



Product Description

The Elen is a surface mounted reading light with a subtle swivel of up to 5 degrees. It contains LEDs in the colour daylight and is operated with a 2 position mini rocker switch. The Elen is compact with a high light output and satin finish. It's ideal use is as a compact reading light in boats or motorhomes.

Summary

- Satin finish
- Rocker switch
- 24 Daylight LEDs
- Surface mounted
- L102 x W77 x H40 mm

Product	Voltage/V	Current/A	Power/W	LED Colour
J9691	12	0.2	2.0	Daylight

Hina



Product Description

The Hina is a tidy, surface mounted reading light. It has a 2 position rocker switch for easy operation and the ability to pivot the direction of light up to 25 degrees. The Hina has a stylish satin finish and is a great addition to boats and motorhomes where a compact and energy efficient light is desired.

Summary

- Satin finish
- Rocker switch
- 6 Cool white LEDs
- Surface mounted
- Ability to pivot
- Ø80 x H48 mm

Product	Voltage/V	Current/A	Power/W	LED Colour
JC283LED	12	0.2	2.5	Cool White



Vela



Product Description

The Vela is a compact reading light that can swivel when open, providing bright illumination in the direction required and close to a low profile downlight. The Vela contains white LEDs and dims to red, ideal in boats where the red courtesy light assists in providing ambient light that doesn't impair night vision. The image (left) shows the Vela in an open position.

Summary

- Satin finish
- Push switch
- 12 Cool white + red dim LEDs
- Surface mounted
- Ability to swivel
- L84 x W75 x H25 mm

Product	Voltage/V	Current/A	Power/W	LED Colour
J3351	12	0.13	1.5	Cool White + Red

Vesta



Product Description

The Vesta is a compact courtesy light great for ambient lighting of stairways and floor areas. The Vesta contains 3 LEDs and has a waterproof rating of IP66, making it suitable for use in interior and some exterior contexts. It has a satin finish and is available with blue or cool white LEDs.

Summary

- Satin finish
- Unswitched
- 3 Cool white or blue LEDs
- Surface mounted
- IP66
- L86 x W33 x H10 mm

Product	Voltage/V	Current/A	Power/W	LED Colour
J1067B	12	0.02	0.2	Blue
J1067	12	0.02	0.2	Cool White

Steplite

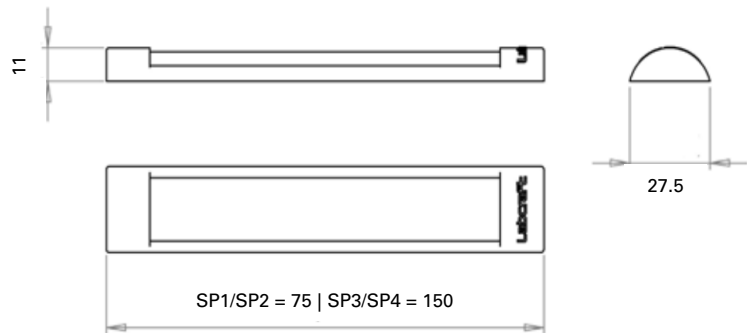
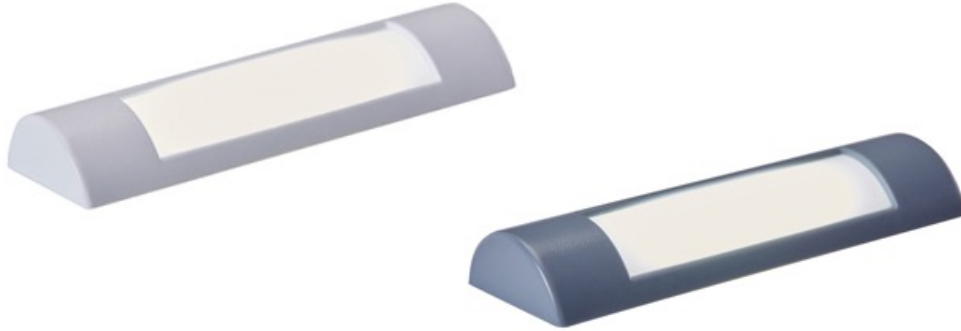

Product Description

The Steplite is ideal for a discrete lighting solution or a subtle illumination of boat and motorhome pathways and cabins. The stylish and compact Steplite comes in two different lengths as well as the choice of surrounds to suit its environment. The Steplite has a low power consumption offering optimum performance and extended life. It's two fixing points make the surface mounted light quick and easy to install and the half open surround ensures light is directed where desired or can be left off altogether to illuminate locker areas.

Summary

- Satin or white finish
- Unswitched
- 6 or 12 Cool white LEDs
- Surface mounted
- 160 - 320 Lumens
- IP50
- SP1 & SP2 - L75mm
- SP3 & SP4 - L150mm
- W27.5 x H11 mm

Product	Length/mm	Voltage/V	Current/A	Power/W	No of LEDs	Light Output/lm	Finish
SP1	75	12	0.12	1.4	6	160	Satin
SP2	75	12	0.12	1.4	6	160	White
SP3	150	12	0.24	2.9	12	320	Satin
SP4	150	12	0.24	2.9	12	320	White

All variants available in 24V or with IP66 waterproof rating on request



MI Systems stocks a wide range of exterior lighting for use in caravans, motorhomes, boats, trucks and commercial vehicles. With a collection sourced from Labcraft, Bestlight and our home brand MI Lighting. MI Systems supplies to manufacturers throughout New Zealand. The range of pricing and warranty options means there will be something to suit every need.

EXTERIOR LIGHTING

Awning Lights

Astro	44
Astro PIR	45
Nova	46
S16 Scenelite	47
S17 Scenelite	48
S18 Scenelite	49
S19 Scenelite	50
S12 Scenelite	51
Aurora	52
Ursa	53
Nima & Faye	54

Outdoor Lights

Nebula	55
Nebula PIR	56
Orizon	57
Novalux	58
Hyperlux & Powerlux	59
Banksman	60
LumoBeam	61
Lunalux	62
Pollux	63
Microlux & Superlux	64

Work Lights

Hydrus	65
--------	----

SCAN HERE
To view comparisons in
light levels across our
range of Awning Lights



Astro

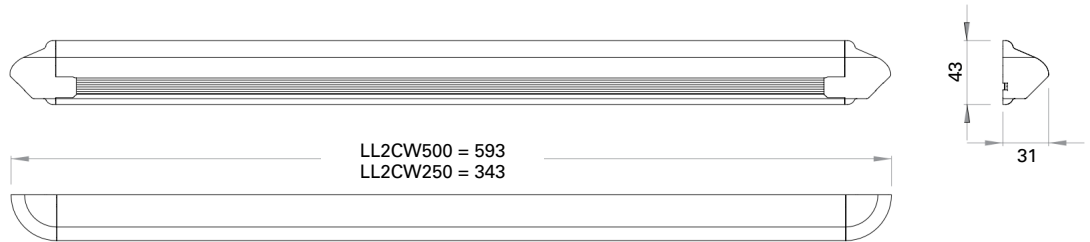

Product Description

The Astro is a popular and robust outdoor awning light installed in many existing motorhomes across Australasia . The Astro Awning light delivers a wide spread of light, perfectly angled for awning and area lighting. It is quick and easy to install, fixed in place by screws at either end, which are discretely hidden by ABS snap-on end caps. The Astro is available in two lengths and three configurations of LEDs, offering a choice of light output to suit every application. White replacement end caps and LED strips to upgrade or refresh your existing Astro Awning light can be purchased separately.

Summary

- White finish
- Unswitched
- Choice of 12, 24 or 48 Cool white CREE LEDs
- Surface mounted
- Up to 1280 lumens
- IP66
- Length 343 or 593 mm
- W43 x H31 mm

Product	Length/m	Voltage/V	Current/A	Power/W	Light Output/lm	LED Colour
LL2CW250	343	12	0.24	3.0	320	Cool White
LL2CW250 24V	343	24	0.44	6.0	320	Cool White
LL2CW250-24	343	12	0.44	6.0	640	Cool White
LL2CW500	593	12	0.44	6.0	640	Cool White
LL2CW500 24V	593	24	0.44	6.0	640	Cool White
LL2CW500-48	593	12	1.0	12.0	1280	Cool White
LL2CW500-48 24V	593	24	1.0	12.0	1280	Cool White

Astro PIR

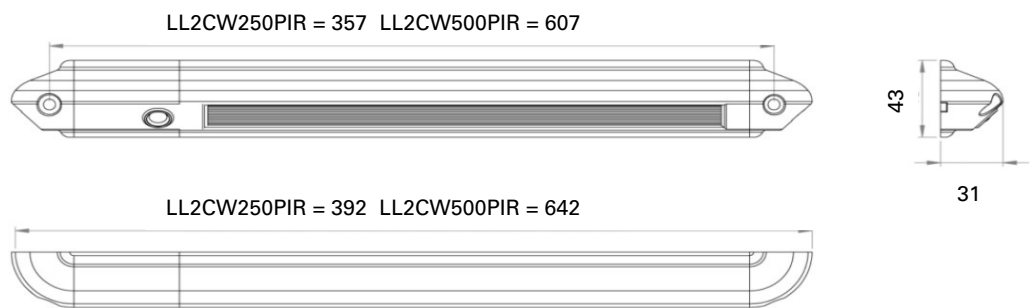

Product Description

The Astro PIR is an updated version of the classic Astro with an added PIR sensor, when no movement of body heat is detected for five minutes, the light will switch itself off, only activating again when body heat is again detected. Particularly useful when you wish for the light to come on when returning to your camper after dark. The Astro PIR is a slim and compact awning light making it a popular choice for many existing motorhomes. Available with two lengths to suit most motorhome contexts, the Astro PIR is a durable and energy efficient choice of awning light that can withstand the elements of cross-country travel.

Summary

- White finish
- PIR Sensor
- Choice of 12 or 24 Cool white CREE LEDs
- Surface mounted
- Up to 640 lumens
- IP66
- Length 392 or 642 mm
- W43 x H31 mm

Product	Length/mm	Voltage/V	Current/A	Power/W	Light Output/lm	LED Colour
LL2CW250PIR	392	12	0.24	3.0	320	Cool White
LL2CW250-24PIR 24V	392	24	0.22	6.0	640	Cool White
LL2CW500PIR	642	12	0.44	6.0	640	Cool White

Nova



Product Description

The Nova is a classic style awning light offering the option of an integrated a PIR sensor. Containing cool white LEDs in a satin or white surround, the Nova proves itself to be a reliable and cost-effective awning light, ensuring it is a popular choice for most motorhome contexts. The PIR switched variant has a slightly slimmer profile and is a great choice when you want your awning light to activate when you arrive at your camper after dark without it running unnecessarily.

Summary

- White or satin finish
- PIR sensor or unswitched
- 36 Cool white LEDs
- Surface mounted
- IP65
- L320 x W100
- Unswitched: H60 mm
- PIR: H30mm

Product	Voltage/V	Current/A	Power/W	LED Colour	Finish	Switch
J6661	12	0.5	6.0	Cool White	Satin	-
J6662	12	0.5	6.0	Cool White	White	-
J6671	12	0.5	6.0	Cool White	White	✓
J6672	12	0.5	6.0	Cool White	Satin	✓

S16 Scenelite

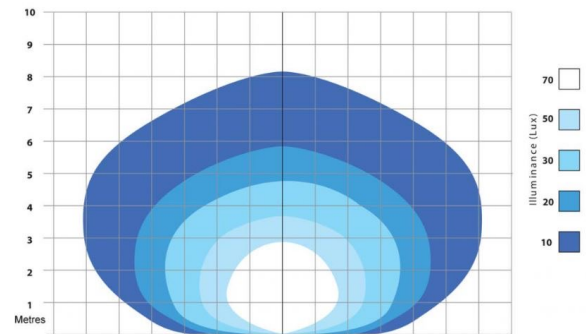
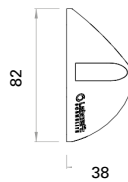
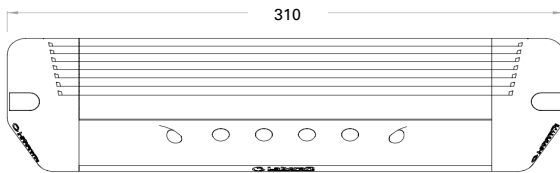

Product Description

The S16 Scenelite is the first lighting choice for many emergency service professionals. The S16 light produces superior illumination and light distribution due to the unique angle of its 6 high powered LEDs. The multi-volt light provides a constant light output of lumens covering over 50m², the brightest in the Scenelite series. The S16 Scenelite has a waterproof rating of IP67, which, paired with its robust exterior makes it a stand-out choice for hard wearing environments. The S16 is available in a colour choice of white, yellow or black all of which are backed by a ten-year warranty.

Summary

- Black, White, or Yellow finish
- Unswitched
- 6 Cool white LEDs
- Surface mounted
- 1872 lumens
- IP67
- L310 x W82 x H38 mm

Product	Voltage/V	Current/A	Power/W	LED Colour	Finish
S16 White	10-32	1.5	18	Cool White	White
S16 Black	10-32	1.5	18	Cool White	Black
S16 Yellow	10-32	1.5	18	Cool White	Yellow

Amps measured at 12V

S17 Scenelite

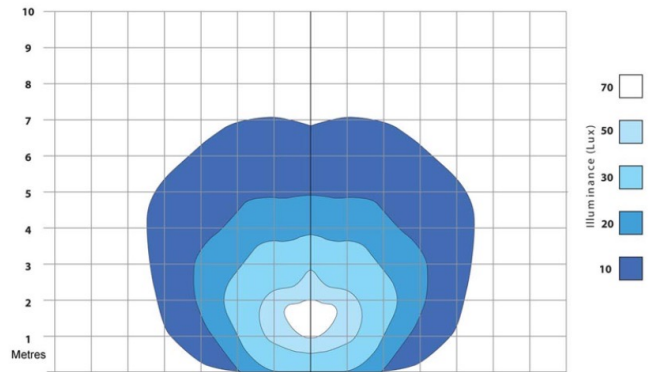
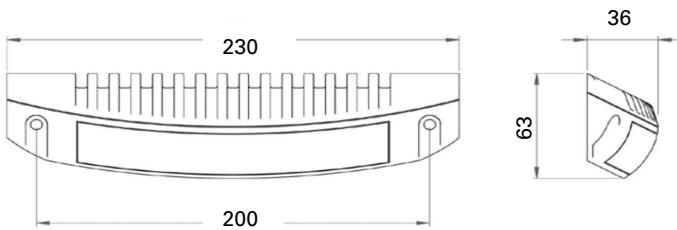

Product Description

The S17 Scenelite contains 5 high output CREE LEDs. These are encased in a solid aluminium casing, creating a robust and powerful light, ideal for hardworking emergency vehicles. The curved profile of the S17 offers improved light distribution, covering an area over 30m² for safer working conditions. The S17 Scenelite is available in a choice of colours, including black, white, red or yellow to suit a range of recreational and emergency vehicles.

Summary

- Black, White, Red or Yellow finish
- Unswitched
- 5 Cool white LEDs
- Surface mounted
- 1560 Lumens
- IP67
- Curved profile
- L230 x W63 x H36 mm

Product	Voltage/V	Current/A	Power/W	LED Colour	Finish
S17 White	10-32	1.25	12.5	Cool White	White
S17 Black	10-32	1.25	12.5	Cool White	Black
S17 Red	10-32	1.25	12.5	Cool White	Red
S17 Yellow	10-32	1.25	12.5	Cool White	Yellow

Amps measured at 12V

S18 Scenelite

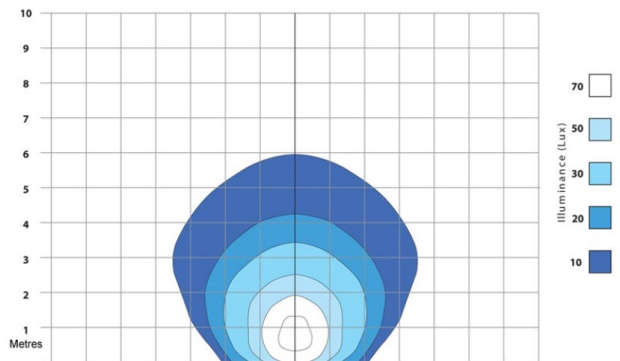
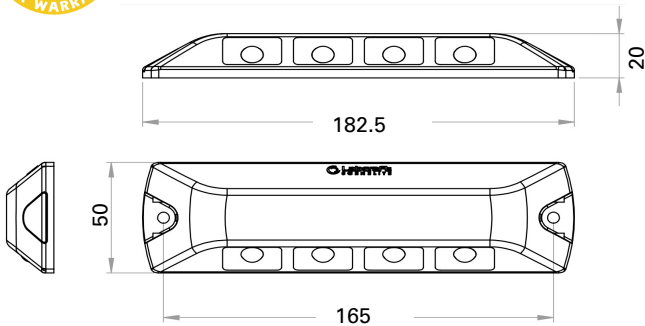

Product Description

The S18 Scenelite is a compact yet robust awning light from the Scenelite range, available in yellow, white and black colourways. The S18 Scenelite contains four long life, high intensity CREE LEDs producing an even spread of light covering over 20m². The solid aluminium base and tough outer enclosure protect inner components with a waterproof rating of IP67 ensures the light is a small but powerful light in the scenelite range.

Summary

- Black, White or Yellow finish
- Unswitched
- 4 Cool white LEDs
- Surface mounted
- 1248 Lumens
- IP67
- L182.5 x W50 x H20 mm

Product	Voltage/V	Current/A	Power/W	LED Colour	Finish
S18 White	10-32	1	12.3	Cool White	White
S18 Black	10-32	1	12.3	Cool White	Black
S18 Yellow	10-32	1	12.3	Cool White	Yellow

Amps measured at 12V

S19 Scenelite

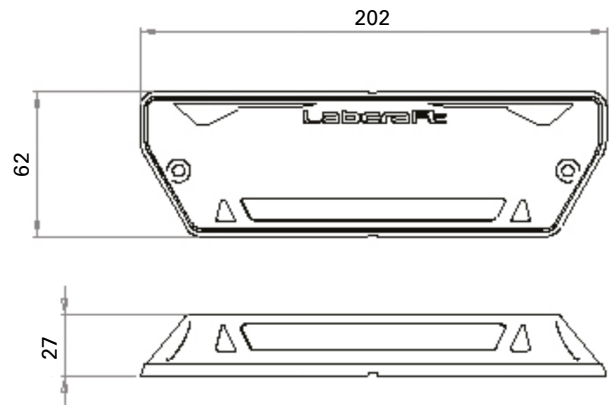

Product Description

The S19 Scenelite is a compact and cost-effective awning light available in a black or white finish. It has a slim, low-profile design making it ideal for use in a multitude of environments including rescue vehicles, tail lift lighting, utility vans and in the 4x4 sector. The S19 is available in 12V and backed by Labcrafts impressive ten year warranty.

Summary

- Black or White finish
- Unswitched
- 8 Cool white LEDs
- Surface mounted
- 852 Lumens
- IP67
- L202 x W62 x H27 mm

Product	Voltage/V	Current/A	Power/W	LED Colour	Finish
S19 White	12	0.5	6.0	Cool White	White
S19 Black	12	0.5	6.0	Cool White	Black

S12 Scenelite

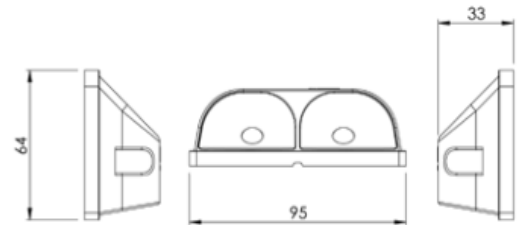

Product Description

The S12 Scenelite is a versatile and compact light designed to be used for such things as tail-lift or entryway lighting however its compact and simple design leaves it open to use in a multitude of contexts. The S12 has a robust polycarbonate housing which makes the light resistant to impacts that can occur when used in a range of rugged environments, ensuring it will last the test of time. The S12 Scenelite is backed by a five-year manufacturer's warranty.

Summary

- Grey finish
- Unswitched
- 2 Cool white LEDs
- Surface mounted
- 624 lumens
- IP67
- L95 x W64 x H33mm

Product	Voltage/V	Current/A	Power/W	LED Colour	Finish
S12	10-32	0.5	6	Cool White	Grey
Amps measured at 12V					



Product Description

The Aurora is a simple and timeless looking LED awning light great for illuminating small awning areas or the side of motorhomes. The Aurora is cost effective and multi voltage making it suitable for larger motorhomes or vessels that operate on a 24V system also. It's daylight coloured LEDs give a softer light aesthetic when a bright white light output is not desired. White replacement covers can be purchased separately to make an existing Aurora look as good as new.

(See page 81)

Summary

- White finish
- Unswitched
- 6 Daylight LEDs
- Surface mounted
- IP66
- L248 x W88 x H55 mm

Product	Voltage/V	Current/A	Power/W	LED Colour
J285LED	10-32	0.2	2.4	Daylight
J285LED Cover	Aurora white replacement cover (more info on page 80)			
	Amps measured at 12V			

Ursa



Product Description

The Ursa awning light is sturdy and reliable awning light with an integrated rocker switch to allow the user to switch the light on and off directly at the light fitting if desired. The Ursa awning light contains 48 LEDs and is available in a white or satin finish to suit most motorhome or boat aesthetics.

Summary

- White or satin finish
- Rocker switch
- 48 Cool white LEDs
- Surface mounted
- IP66
- L205 x W115 x H48 mm

Product	Voltage/V	Current/A	Power/W	LED Colour	Finish
J88931	12	0.3	3.5	Cool White	Satin
J88932	12	0.3	3.5	Cool White	White

Nima



Product Description

The Nima is a classic style, oval-shaped awning light available in a white or satin finish. Its sleek look compliments many motorhome exteriors, and its 24 super bright LEDs it makes the Nima a cost effective yet bright choice for illuminating your motorhome awning area.

Summary

- White or satin finish
- Unswitched
- 24 Cool white LEDs
- Surface mounted
- IP66
- L200 x W100 x H50 mm

Product	Voltage/V	Current/A	Power/W	LED Colour	Finish
J7771	12	0.25	3.0	Cool White	White
J7772	12	0.25	3.0	Cool White	Satin

Faye



Product Description

The Faye awning light is a low cost, switched exterior light, suitable for use in a range of motor homes and boats. The Faye's 2 position rocker switch allows for easy switching of the light without the need for installing an additional switch, while its waterproof switch cap ensures the light remains water-tight.

Summary

- White finish
- Rocker switch
- 12 Cool white LEDs
- Surface mounted
- IP66
- L173 x W110 x H56 mm

Product	Voltage/V	Current/A	Power/W	LED Colour
J1122	12	0.2	2.0	Cool White

Nebula

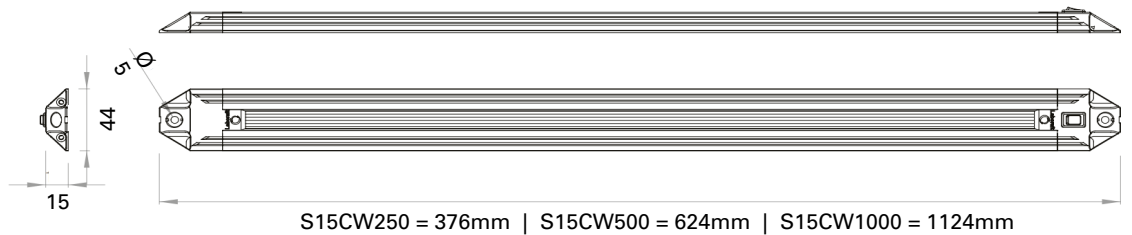
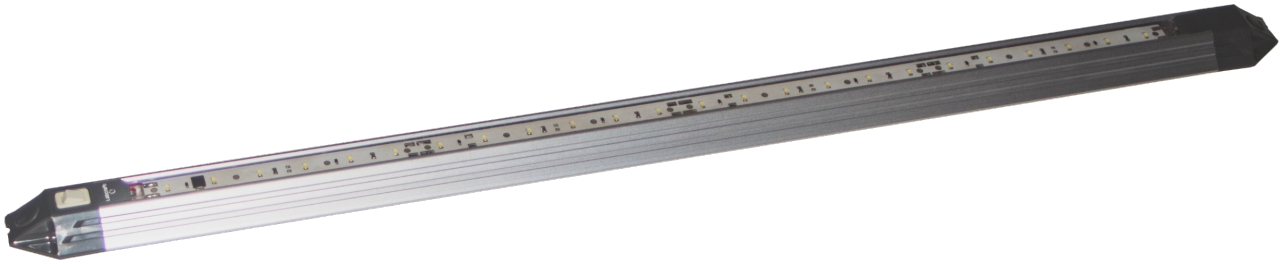

Product Description

The Nebula is a surface mounted strip light available in three convenient lengths, fitted with the Orizon LED strip which uses the latest in LED technology to offer optimum light output. The Nebulas tough aluminium extrusion offers a durable but low-profile housing that is easy to install in a range of contexts whether it is for a new build or for retrofitting into an existing vehicle. The choice of unswitched or switched options allows you to choose between a

Summary

- Aluminium housing
- Rocker switch or unswitched
- Up to 48 Cool white LEDs
- Surface mounted
- Up to 1280 Lumens
- IP66 (unswitched only)
- Length 376, 624 or 1124mm
- W44 x H15 mm

Product	Length/mm	Voltage/V	Current/A	Power/W	No of LEDs	Light Output/lm	Waterproof	Switch
S15CW250 SW	376	12	0.25	3.0	12	320	IP60	✓
S15CW250	376	12	0.25	3.0	12	320	IP66	-
S15CW500 SW	624	12	0.5	6.0	24	640	IP60	✓
S15CW500	624	12	0.5	6.0	24	640	IP66	-
S15CW1000 SW	1124	12	1.0	12	48	1280	IP60	✓
S15CW1000	1124	12	1.0	12	48	1280	IP66	-

All variants available in 24V on request

Nebula PIR

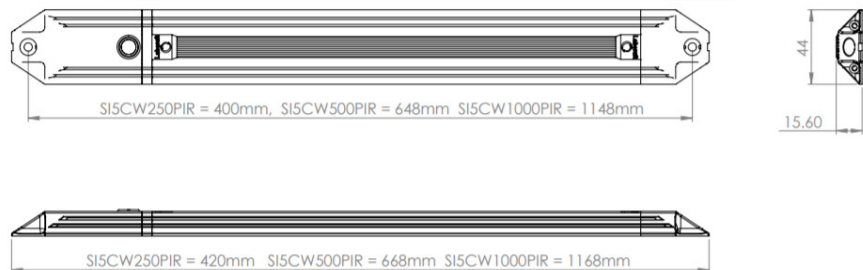

Product Description

The Nebula PIR is a modified version of the classic Nebula, boasting the benefits of the classic Nebula light such as the hard wearing, low profile aluminium extrusion and energy efficient, super bright Orizon light strips. In addition, the fitting contains a PIR sensor designed to detect the movement of body heat. This allows the light to be fitted in hard wearing environments where sometimes switching options are limited for example gear lockers in horse floats, and illumination in delivery trucks as the light will automatically switch off after five minutes of no body heat movement and re-activating when you need it most.

Summary

- Aluminium housing
- PIR Sensor (5min)
- 12 Cool white LEDs
- Surface mounted
- IP60
- Length 420mm
- W44 x H15.6 mm

Product	Length/mm	Voltage/V	Current/A	Power/W	Output/lm	LED Colour
S15CW250 PIR	420	12V	0.24	3.0	320	Cool White

Orizon

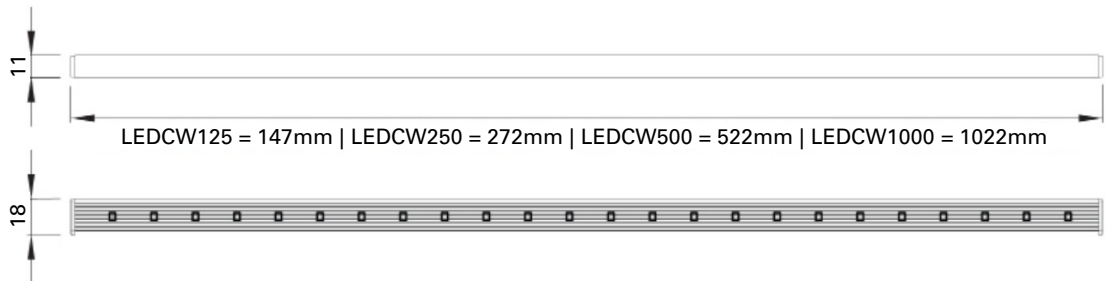

Product Description

The Orizon LED strip is a versatile light bar that can be mounted to provide robust, discrete lighting in a variety of contexts, The Orizon can be mounting using adhesive strip or fixing with mounting saddles. The Orizon can also be used to update and brighten old Astro, Nebula or Appolo light fittings by switching out an older light bar with a newer version to offer a brighter and more energy efficient light while maintaining the characteristics of the original light fitting.

Summary

- Clear PC lens
- Unswitched
- Up to 48 Cool white LEDs
- Surface mounted
- Up to 1280 Lumens
- IP66
- Length 147, 272, 522 or 1022mm
- W18 x H11 mm

Product	Length/mm	Voltage/V	Current/A	Power/W	Light Output/lm	LED Colour
LEDCW125	147	12	0.12	1.4	160	Cool White
LEDCW250	272	12	0.24	3.0	320	Cool White
LEDCW500	522	12	0.44	6.0	640	Cool White
LEDCW1000	1022	12	1.0	12	1280	Cool White

All variants available in 24V on request

Novalux

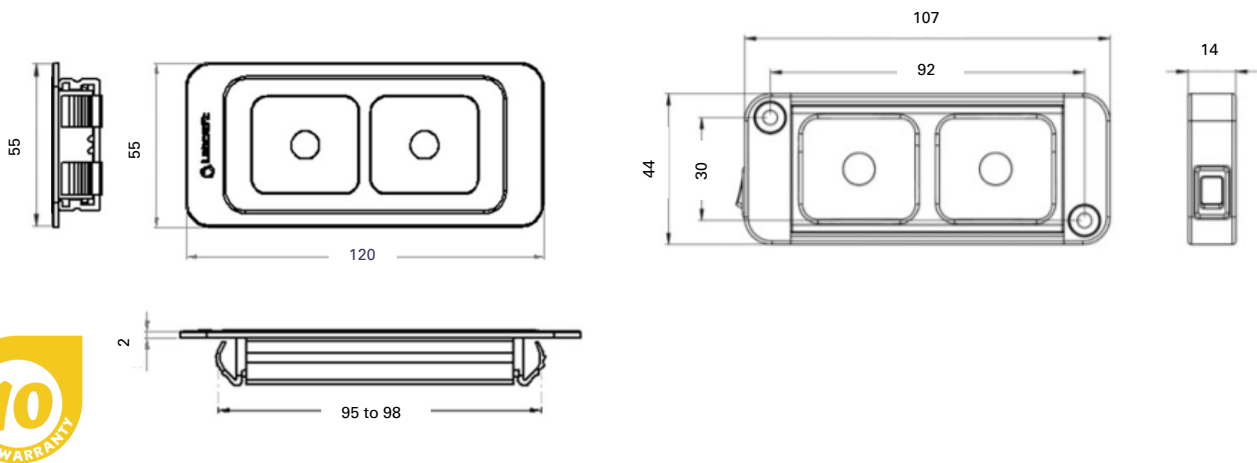

Product Description

The Novalux is a compact but powerful light that suits a wide range of contexts. The surface mount Novalux has a convenient rocker switch for easy installation in locker areas, delivery vans or any other areas that require a compact but bright light. The recessed version boasts an ingress protection rating of IP66 making it an ideal solution in refrigerated vehicles or other damp hard wearing environments.

Summary

- White Finish
- Unswitched or Rocker
- 2 Cool White LEDs
- Surface or recessed mounted
- 354 lumens
- IP66 (unswitched only)
- Surface: L107 x W44 x H14mm
- Recess: L120 x W55 x H2mm



Product	Length/mm	Voltage/V	Current/A	Power/W	LED Colour	Waterproof	Switch	Mount
T13_2-1MVS	107	10-30	0.22	2.7	Cool White	IP60	✓	Surface
T13R_2-1MV	120	10-30	0.22	2.7	Cool White	IP66	-	Recessed

Amps measured at 12V

Hyperlux & Powerlux

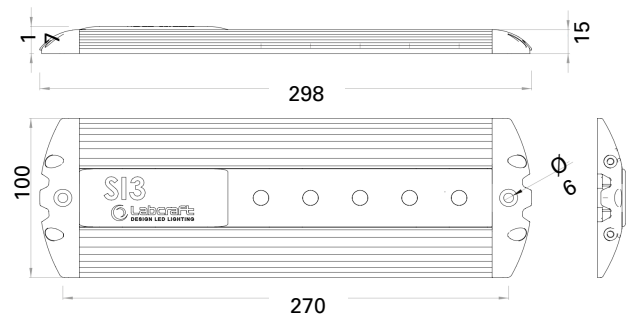
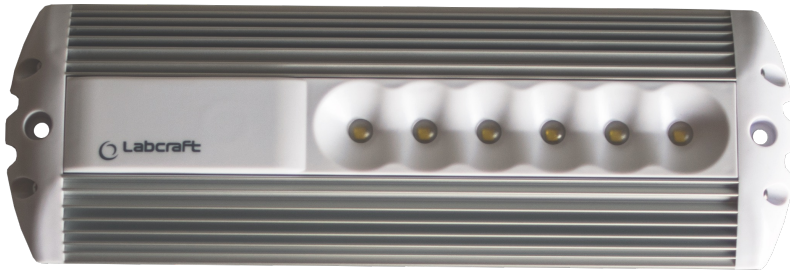

Product Description

The Hyperlux and Powerlux lights by Labcraft are powerful and hard-wearing fittings designed with a unique impact deflection construction. This makes these lights an excellent choice for rugged environments where an efficient and bright light is required such as marine engine rooms and refrigerated vehicles. If desired, both units can be produced with an integrated PIR switch to allow the fittings to turn on when required before switching off once no body heat has been detected for five minutes.

Summary

- White or Red
- Unswitched or PIR on request
- 5-6 Cool white LEDs
- Surface mounted
- Up to 1872 lumens
- IP67
- L298 x W100 x H15 mm

Product	Voltage/V	Current/A	Power/W	Light Output/lm	LED Colour	Finish
Hyperlux	10-32	1.5	18	1872	Cool White	White
Powerlux	10-32	0.75	9.0	1194	Cool White	Red

Amps are measured at 12V

Banksman

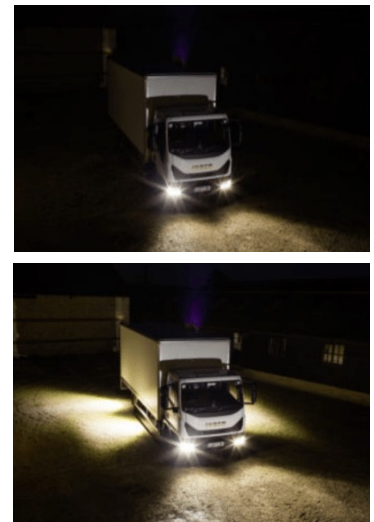
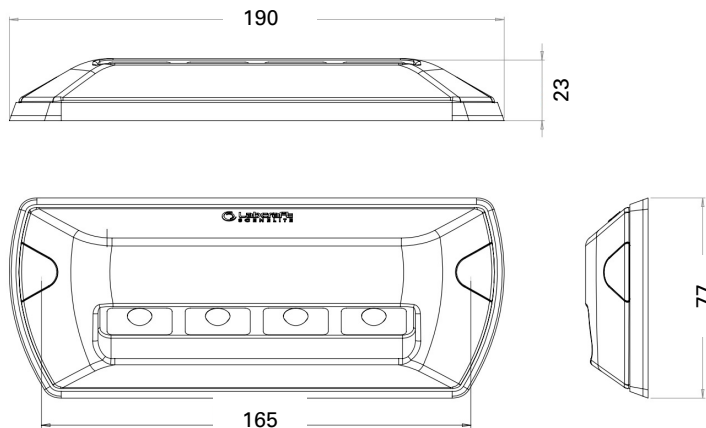

Product Description

The Banksman manoeuvring aid has been designed to mount on the undercarriage of trucks or other large vehicles to deliver additional bright white light to the sides of any vehicle where traditional reversing lights cannot cover. Fitted around the chassis of trucks, trailers and emergency vehicles the banksman directs a bright light downwards and away from the vehicle, illuminating the area around and creating a safer working environment while reducing the likelihood of accidents and collisions incurred while the vehicle is manoeuvring.

Summary

- Black finish
- Unswitched
- Surface mounted
- 956 Lumens
- IP67
- L190 x W77 x H23 mm

SCAN HERE

To watch a demonstration video on the Banksman BM3



Product	Voltage/V	Current/A	Power/W	LED Colour
BM3	10-32	0.68 max	8.2	Cool White

Amps measured at 12V

LumoBeam

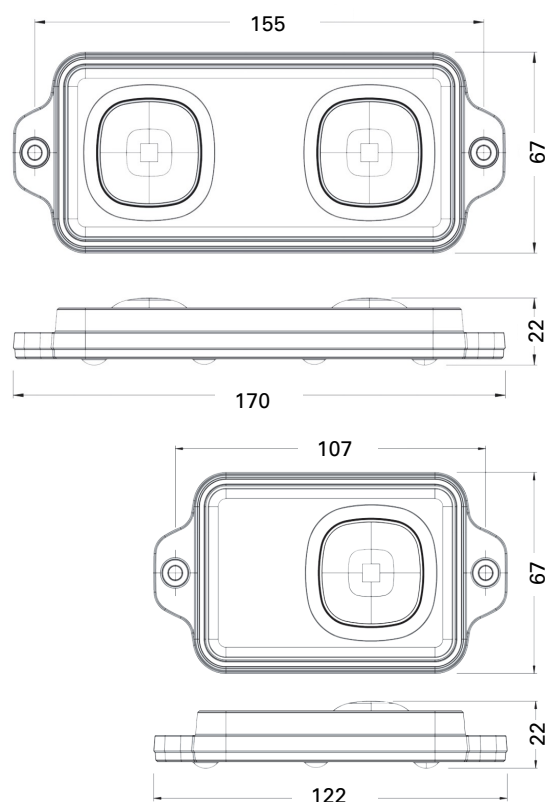

Product Description

The LumoBeam light is ideal for hardwearing environments such as on boats or in cargo spaces on vans or trucks. Shining brighter and more effectively than other lights, the LumoBeam helps improve delivery times with precise task lighting. The LumoBeam is available in either a spot or wide lens to ensure light is dispersed accurately and precisely as required. The single beam has a light output of 900 lumens and the double beam has 1800 lumens of light output.

Summary

- Blue finish
- Unswitched
- Single or double beam LEDs
- Spot or wide lens
- Surface Mount
- Up to 1800 Lumens
- IP67
- Length 122 or 170mm
- W67 x H22 mm

Product	Length/mm	Voltage/V	Current/A	Power/W	No of Beams	Light Output/lm	Lens
F2810	122	9-30	0.75	9.0	Single	900	Spot
F2811	122	9-30	0.75	9.0	Single	900	Wide
F2813	170	9-30	1.5	18	Double	1800	Wide
Amps measured at 12V							

Lunalux



Product Description

The Lunalux is a compact and powerful light suitable for a range of hard-wearing environments including livestock trailers, engine rooms and refrigeration vehicles. The Lunalux is constructed of a powder coated aluminium casting which ensures the LEDs run as cool as possible for longer life while potting over more sensitive components gives the light an IP67 rating and provides protection against a variety of harsh operating conditions.

Summary

- White Finish
- Unswitched
- 2 Bright White LEDs
- Surface mounted
- 655 lumens
- IP67
- L122x W70x H15mm

Product	Voltage/V	Current/A	Power/W	LED Colour
PS3	10-30	0.45	6	Cool White

Amps measured at 12V

Pollux



Product Description

The Pollux is a durable, high powered ceiling lamp perfect for engine rooms, gear lockers and any other hard-wearing environment requiring a bright light output. The pollux is available with a variety of switching choices including a PIR sensor for touch free switching, a push switch or unswitched to allow for a convenient external switch to be fitted. This allows you to use the coordinated range of Pollux lights throughout a range of contexts.

Summary

- White finish
- Push switch, PIR switch or unswitched
- 36 Cool white LEDs
- Surface mounted
- 450 Lumens
- IP66
- L155 x W124 x H14 mm

Product	Voltage/V	Current/A	Power/W	LED Colour	Switch
J9003	12	0.6	7.0	Cool White	PIR
J90031	12	0.6	7.0	Cool White	-
J90032	12	0.6	7.0	Cool White	Push

Shown in image (left to right): J9003, J90032

Microlux & Superlux

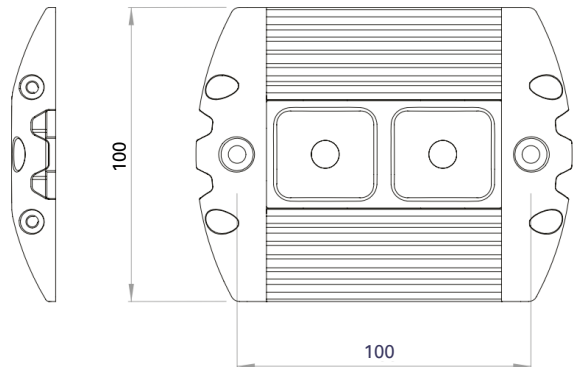

Product Description

The Microlux and Superlux lights by Labcraft are manufactured with a unique low profile impact deflection design, making them perfect for even the hardest wearing environments where a compact but durable, bright light is required. This includes in ship engine rooms, utility vehicles and trucks where lights are required to be bright and may sustain knocks in daily use.

Summary

- Unswitched
- 2 Cool white LEDs
- Surface mounted
- Up to 624 Lumens
- IP67
- L128 x W100 x H15 mm

Product	Voltage/V	Current/A	Power/W	Light Output/lm	LED Colour	Finish
Superlux	10-32	0.5	6.0	624	Cool White	White
Microlux	10-32	0.23	2.7	354	Cool White	Black

Amps measured at 12V

Hydrus



Product Description

The Hydrus work light is a compact and waterproof light with an aluminium die-casted housing, PC lens and marine grade stainless steel bracket. These features make it an excellent choice for illuminating boat cockpits or deck areas of tiny homes. The choice of a spot or wide-angle lens allows you to ensure the light is focussed in the most applicable way for your project, choosing spot directs the beam of light in a more focused area while the spread lens ensures light is dispersed over a wider area.

Summary

- Black or white finish
- Unswitched
- 6 x 1.2W Cool white LEDs
- Wide or spot lens
- 540 Lumens
- IP66
- Pre-wired 2 metre cable
- L100 x W65 x H35 mm

Product	Voltage/V	Current/A	Power/W	LED Colour	Finish	Lens
J22991	10-30	0.6	7.2	Cool White	White	Wide
J22992	10-30	0.6	7.2	Cool White	Black	Wide
J22993	10-30	0.6	7.2	Cool White	White	Spot
J22994	10-30	0.6	7.2	Cool White	Black	Spot

Amps measured at 12V

Shown in image (left to right): J22991, J22994

PARTS & ACCESSORIES

MI systems stocks a range of accessories for boats, motorhomes and commercial vehicles. The LED bulbs allow for an upgrade from fluorescent light fittings to more efficient LED solutions. A range of sensors and gauges are available for use in boats in addition to accessories for motorhome interiors.

Emergency Escape Light	67
Vanlite	68
Portable Light Bar	70
LED Bulbs	72
Sensors & Gauges	73
Seat Net	74
BACKSEE Wide Angle Lens	74
Table Legs	74
Voltage Reducer	75
PIR Sensor Control	75
Cigarette Lighter Adapter	75
LED Handle	75
Heater	76
Solar Vent	77
Replacement Parts	78

Emergency Escape Light

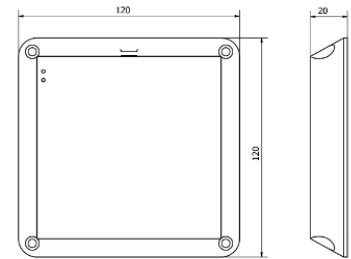

Product Description

The EEL Emergency Escape Light was created to help prevent loss of life at sea. When a vessel capsizes it can leave the crew or passengers in complete darkness, upside down and disoriented. EEL's control PCB registers when the vessel rolls over a certain degree, activating immediately with a powerful 300+ lumen output. The EEL is built with high quality components to withstand impact from fallen objects. The unit has a minimum 6 hour battery life. EEL is IP67 rated, also activating on detection of water during flooding. The EEL is designed to be installed fixed, or with an option of a bracket to remove if required, and has no external wiring for easy installation. The product has a built in test mode and a 2 year standby battery life – which can then be serviced by registered service centres.

Summary

- Clear finish
- Self-activating
- 8 Cool white LEDs
- Surface mounted
- 300 Lumens
- IP67
- L120 x W120 x H20mm



Product	Light Output /lm	LED Colour	Finish
3392301	300	Cool White	Clear

Vanlite



Product Description











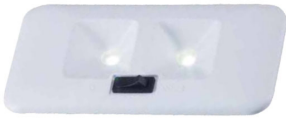

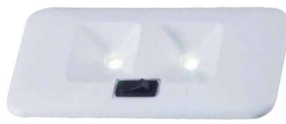





The Vanlite is an ideal accessory for industrial vehicles. It directly replaces existing original manufactured interior lights offering up to 7 times more light while using half the power. The Vanlite is recessed and easy to install, designed to easily replace the interior vehicle light of many major models of vans and utes, being a direct replacement in size and power connector. The Vanlite range is constructed from PC and aluminium for a robust fitting while using the latest Cree LED technology to allow for optimum performance and extended life.

Summary

- White finish
- Switched or unswitched
- 2 Cool white LEDs
- Recessed mount
- Up to 624 Lumens
- IP60

Technical Specification	VANLITE Model	
	V10, V11, V30, V35, V40, V50, V60	V20
Polycarbonate body	✓	✓
Aluminium heatsink	✓	✓
Lumens	624	479
Average Current	0.45A	0.35A
Power	6W	4.2W
Waterproof Rating	IP60	IP50



Product	QR for Spec Sheet	Vehicle Make	Vehicle Model
V10  Surface: L140x70xD8.6mm Recess: L119xW52xD25mm		Nissan Renault Renault Vauxhall Vauxhall	NV200/NV300/NV400 Master (1997 onwards) Trafic (2001 onwards) Movano (1997 onwards) Vivaro (2001 onwards)
V11  Surface: L140x70xD8.6mm Recess: L119xW52xD25mm		Citroen Citroen Peugeot Peugeot Peugeot	Berlingo Dispatch (Pre 2017) Bipper Expert (Pre 2017) Partner
V20  Surface: L70xW50xD10mm Recess: L62xW30xD16.5mm		Ford Ford Ford Ford	Transit Courier Transit Connect SWB & LWB Transit Custom Transit Van
V30 3-way switch  Surface: L138xW60mm Recess: L130xW44xD25mm		Mercedes VW	Sprinter Crafter (Pre 2017)
V31 Non-switched  Surface: L138xW60mm Recess: L130xW44xD25mm		Mercedes Mercedes	Sprinter Vito (Pre 2016)
V35 Trigger switch  Surface: L138xW60mm Recess: L130xW44xD25mm		Mercedes	Vito (2016 onwards)
V40  Surface: L135mm Recess: L120xW53xD25mm		Citroen Fiat Fiat Peugeot Vauxhall Vauxhall	Relay Doblo Ducato Boxer Combo Vivaro (Pre 2001)
V50  Surface: L165mm Recess: L154.20xW44xD25.20mm		Renault Renault Renault Vauxhall Vauxhall	Kangoo (2007 onwards) Master (1997 onwards) Trafic (2001 onwards) Movano (1997 onwards) Vivaro (2001 onwards)
V60  Surface: L136mm Recess: L135xW51xD25mm		VW VW VW	Transporter Caddy Crafter (2017 onwards)

Portable Light Bar



Product Description

The Portable Light Bar is an excellent choice when extra light is required. Its Li-ion battery is rechargeable and has the capacity to keep the light illuminated on low power for up to 43 hours. The Light Bar contains a micro USB port for convenient recharging, as well as multiple lighting options, including three dimming levels and strobe functions operated by a push switch. It is very handy and easy to carry, as well as an ideal portable option for your cupboards or lockers that are difficult to get a power supply to. Various accessories are available with the Light Bar in addition to built-in magnetic mounts. The Light Bar is constructed with an aluminium base & PC lens.

Summary

- White finish
- Push switch
- Cool white LEDs
- Magnetic mounts
- Rechargeable via micro USB
- Accessories available
- L215 x W35 x H37 mm

Product	Length/mm	Battery Capacity	Battery Life		LED Colour
JV-215	215	4400 mAh	4.5 hr at 329 Lm	43 hr at 35 Lm	Cool White

Light Bar Accessories

Product Description

The Portable Light Bar has a range of accessories. These include a pole clamp, suction cup, iron stickers, belt clip kit, carrying strap and waterproof bag. The iron stickers are a popular choice, creating a magnetic surface for the light bar to mount on. A USB charging cord is also available to charge the Portable Light Bar.



Suction Cup

USB Cord (2A)



Pole Clamp

Red PC Cover Lens

Product	Product Description
JV-MS	Multi-functional stand
JV-SC	Suction cup
JV-CB	Carrying strap
JV-MT	Magic tape
JV-BC	Belt clip kit
JV-PC	Pole clamp
JV-UC	USB charging cord (2A)
JV-WB	Waterproof bag
JV-EC	Silicone end caps (2pcs)
JV-IS	Iron stickers (2pcs)
JV-SR	Stainless wire strap (2pcs)
JV-RC	Red PC cover lens



Belt Clip Kit

Iron Stickers (2pcs)

Silicone End Caps

LED Bulbs



Bayonet Bulbs

Bayonet LED bulbs are available with offset or parallel pins as well as single or double contacts. Warm white and cool white variants are available with the choice of 13 or 27 LEDs.



Festoon Bulbs

LED festoon bulbs are a simple replacement for existing halogen festoon bulbs. We recommend the warm white variant for use in upgrading navigation lights on boats.

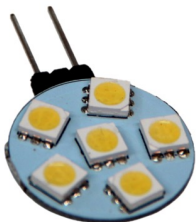

G4 LED Bulbs

G4 LEDs are available in a variety of patterns with 6 or 12 LEDs. Cool white or warm white variants are available, with either back pin or side pin fittings. The side pin variants are a quick and easy replacement for many halogen bulbs in boat and motorhome down lights.



MR11/MR16 LED Bulbs

MR11 and MR16 LED bulbs are a convenient replacement for existing halogen MR11 and MR16 fittings to save on power consumption without compromising on light. These bulbs are available in cool white and warm white, operating within 10-30V.



Wedge LED Bulbs

LED light bulbs with a wedge shaped base for easy retrofitting in existing light fittings. Available with 10 or 13 LED options, emitting 0.8W or 1.6W. with wedge sizes of 10mm or 16mm.

Sensors & Gauges

Gauges

Sensotex gauges for water, fuel and holding tanks.

Product	Product Description
JHF-05	Sewage tank controller
JHW/ JHF-05 set	Gauge meter indicator for sewage tank SW and 6m cables
JHW-01	Gauge meter indicator UNSW+ JHF-05 and 6m cables
JHW-01S	Gauge meter indicator SW
JMP-02F	2 Fuel tank gauge
JMP-02W	2 Water tank gauge
JMP-02WF	Mixed fuel/water tank gauge
JMP-04	Fuel tank gauge
JMP-05	Holding tank gauge



Sensors

Sensotex sensors suitable for water, fuel and holding tanks are available in stainless steel, plastic, and nylon. They are fully enclosed with a variety of lengths available, longer sensors can be discussed to meet your needs if required.



Product	Product Description	Choice of Length (mm)
JFW-04	Stainless Steel Sensor	200, 250, 300, 350, 400, 500, 600, 800
JFW-05	Plastic Sensor	250, 300, 350, 400, 500, 600, 800
JFW-06	Nylon Sensor	100, 150, 200
JHF-02	Holding Tank Sensor	113, 217, 321, 425

Accessories



Seat Net

Keep your maps, tickets and gadgets organised with this easy to install elastic Seat Net. It measures 315 x 210mm.

Product Code: JO-5063



BACKSEE Wide Angle Lens

BACKSEE widens your field of vision when reversing, reducing the risk of harm to pedestrians or other drivers, or of damaging your vehicle in a tight parking spot. It is easily applied to your rear windscreen with an adhesive backing. For more information scan the QR code below.

Product Code: RL-0810

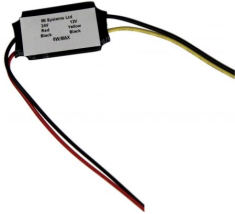

Table Legs

These three-part table legs are ideal for use in your motorhome, caravan, boat or tiny home. Parts can be purchased individually or as a set.

Product	Product Description	Measurements
J1622	Table Leg	Ø55mm x L700mm
J1623	Aluminium standard base	Ø165mm x H45mm & Ø55mm internal
J1624	Aluminium recessed table base	Ø153mm x H50mm & Ø55mm internal

Shown in image (clockwise): J1623, J1622, J1624



C1 Voltage Reducer

The C1 voltage reducer is useful for boats and motorhomes operating on 24V systems that wish to install a light that is only available in 12V. It reduces 24V to 12V, up to 8W and can be discreetly mounted behind most light fittings.

Dimensions excluding wire: 38 x 20 x 7mm

Product Code: C1



PIR Sensor Control Unit

PIR sensors are commonly used for automatically activated lighting systems. They are small, use little power, have a wide lens range and are easy to use. This multi-voltage (10-30V) unit comes with 2 outlet lead sets, each set at a maximum of 2A with a 5 minute delay. The PIR sensor has a diameter of 110mm with a recess cut out diameter of 60mm.

Product Code: J1010-PIR



Cigarette Lighter Adaptor

Keep your devices charged on the go with the cigarette lighter adaptor. Single cigarette lighter input with 2 socket outputs and 2 USB outputs, as well as LED charge light indicators.

10A for use at 12V only.

Product Code: JT6683D



LED Handle

Make a statement with the 12 Volt chrome plated LED handle that glows blue. The 25mm diameter clear acrylic handle is simple to attach with the supplied screws and gaskets. The LED handle is available in a 500mm length with a power output of 1.5W.

Product Code: JO-5089 500mm

MI LIGHTING Accessories



Ceramic Heater

The PTC (Positive Temperature Coefficient) Ceramic Heater uses technology that provides a safe, powerful and energy efficient way to heat your motorhome or boat.

The PTC heater reaches temperatures as high as 110°C and includes a specially treated grill to reduce the risk of heat build-up and burn related injury. It features 3 function settings of fan, heater, or fan and heater as well as high and low fan speed control options. It's swivel Base allows the user to angle the fan/heater up or down for maximum comfort.

Dimensions: L180 x W105 x H175 mm

Power: DC 12V 300W

Product Code: JCF300



Solar Vent

The solar wall vent uses built-in solar panels to operate an interchangeable fan to either inject fresh air or extract unwanted air from the motorhome, caravan, boat or other small space. It is ideal for removing or reducing smells, gases, moisture, mould, mildew and condensation. The solar wall vent can be used alone or in conjunction with additional units to generate a cross flow ventilation system. The solar panels have been created using single crystal silicon solar cells to ensure high efficiency & long-term reliability with no on-going operation costs or pollution. It is easy to install with no wiring required.

Dimensions: L240 x W210.5 x H130 mm

Recess: Ø110 x H60mm

Product Code: SWF101

Replacement parts



Astro End Caps

Keep your Astro awning light looking as good as new by replacing old and discoloured end caps. With an easy snap-on fit it is an easy way to refresh your Astro awning light. Instructions on how to do this can be found by scanning the QR code below.

Product Code:

Left endcap: 414318700

Right endcap: 414318800



Ellipse light Diffusers

The Lumo Ellipse light fittings are commonly seen in motorhomes and caravans throughout Australasia. Over long periods of time their diffusers can discolour; refresh your light fitting with ease by fitting a new diffuser which will give your light a refreshed look and allow a cleaner light through.

Please note: The Ellipse light fittings are now obsolete; we are happy to repair or convert existing units where needed, reach out to the team to discuss your requirements.

Product Code:

Ellipse: E188-050

Replacement parts

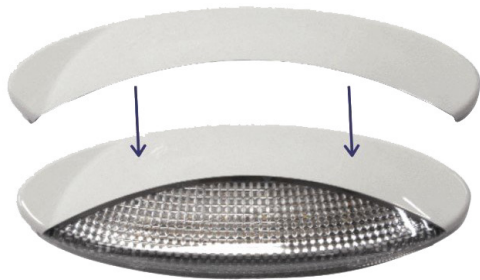

Aurora Cover

The Aurora (Seen on page 54) is an awning light installed on many motorhomes throughout Australasia. Keep your Aurora light looking as good as new by replacing the ABS white cover if yours cracks or discolours over time.

Product Code: J285LED Cover



Orizon Light Bar

Over time our Nebula and Astro lights from Labcraft have become brighter and more energy efficient as LED technology has evolved. Upgrade your existing Astro or Nebula with ease by updating the Orizon LED light strip inside. Strips come in 250mm, 500mm and 1000mm lengths to suit the range of lights.

To view full specs on the Orizon light please refer to Page 59.

Product Code:
LEDCW250
LEDCW500
LEDCW1000

SCAN HERE
To watch a tutorial on how to upgrade your Astro awning light with a new Orizon light bar.

Visit shop.misystems.co.nz for access to stock pricing and availability



Unit 3, 2 Alfred Street
Onehunga, Auckland



sales@misystems.co.nz



(09) 622 1111



www.misystems.co.nz